

Copyright 2004 by the Thomas G. Faria Corporation, Uncasville CT
No part of this publication may be reproduced in any form, in an electronic retrieval system or otherwise, without the prior written permission of the company.
Suzuki® is the trademark of the Suzuki Motor Corporation.

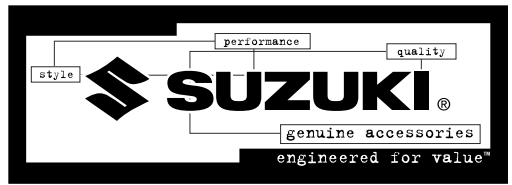

Owner's Manual

Commander™ Speedometer

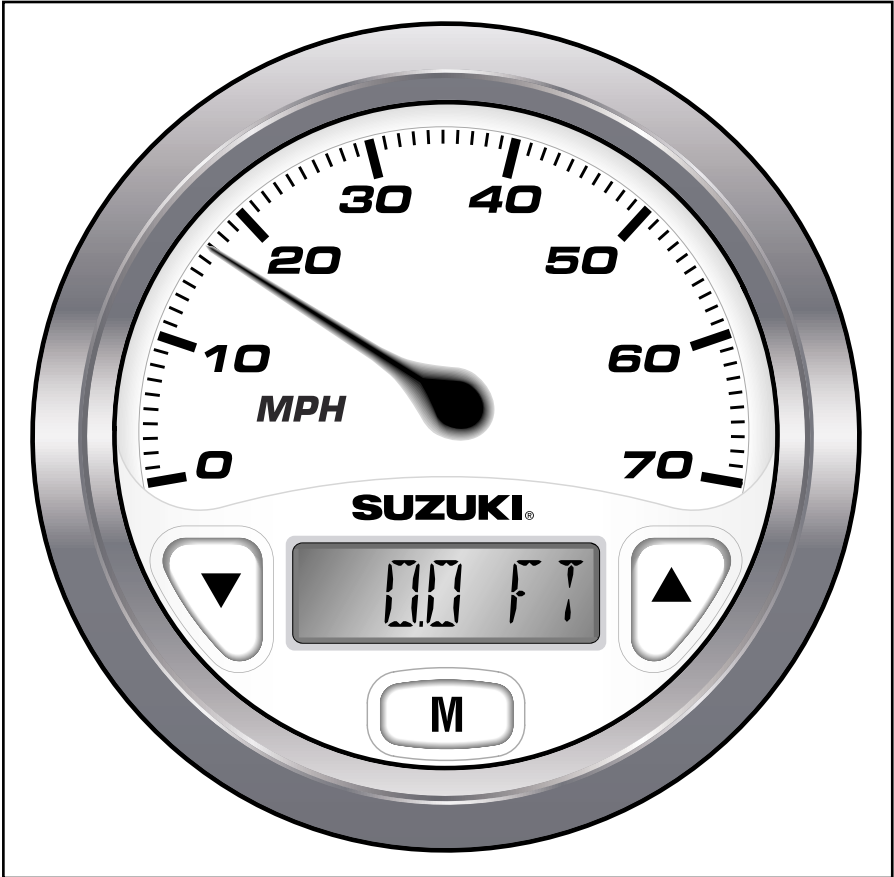

- Digital Speedometer with Analog Appearance
- Digitally displays:
 - Depth in Feet, Meter, or Fathoms
 - Shallow or Deep Water Alarms
- Alarms are Audible and Visual
- Programmable Keel Offset
- Trip Log

Important

 **WARNING**

 **CAUTION**

NOTE

Please read this manual and follow its instructions carefully. To emphasize special information, the symbol  and the words **WARNING**, **CAUTION** and **NOTE** have special meanings. Pay special attention to the messages highlighted by these signal words:

NOTE: *Indicates special information to make maintenance easier or instructions clear.*

 **WARNING**

Indicates potential hazard that could result in death or injury.

 **CAUTION**

Indicates potential hazard that could result in vehicle damage.

Table of Contents

Installation

Figure 1 Installation	Page 1
Power Connector Socket	Page 1
Depth Sounder Connector Socket	Page 1

Operations

Speedometer	Page 2
Lighting	Page 2
Trip Log	Page 2
Reset	Page 3
Units	Page 3
Calibration	Page 3
Depth Sounder	Page 3
Shallow Alarm	Page 4
Deep Alarm	Page 4
Keel Offset	Page 4
Units	Page 4
Loss of Signal	Page 5
Calibration	Page 5
Figure 2 Speedometer LCD Display Modes	Page 7

Set-Up Mode

Speedometer Scale Selection	Page 8
Figure 3 Set-Up Mode	Page 9
Figure 4 Power Socket Connection Wire Diagram	Page 10
Figure 5 Depth Sounder Connection Wire Diagram	Page 11

(This page left blank intentionally.)

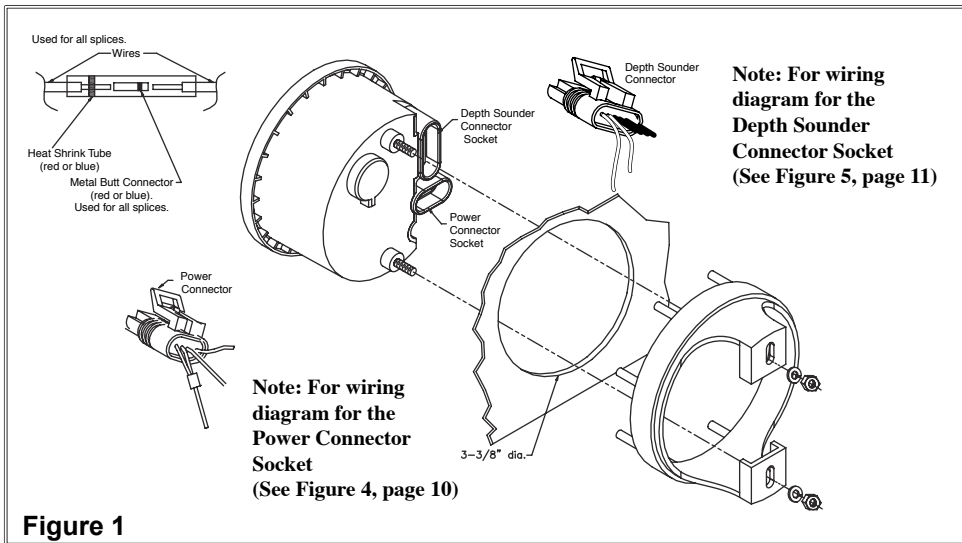

Figure 1

Use this manual for Commander™ Speedometer with depth sounder.

⚠ CAUTION

Disconnect the battery during installation. Tighten nuts on the backclamp only slightly more than you can tighten with your fingers. Six inch-pounds of torque are sufficient. Over-tightening could result in damage to the instrument and may void your warranty.

Tools Required

Ref. Tools Description

1. 3/8" Nut Driver
2. Suzuki Terminal Kit 09900-28701



Installation

1. Cut a 3-3/8" diameter hole in the dash and mount the gauge with the backclamp supplied.

Follow the enclosed instructions for installing the sender. Once the sender is installed and you have run the cables to the Commander, connect the wires from the sender to the corresponding connectors as

illustrated.

2. Power Connector Socket
Follow the wiring diagram at the end of this manual for wiring connections. (See Figure 4, page 10)
3. Depth Sounder Connector Socket
Follow the wiring diagram at the end of this manual for wiring connections. (See Figure 5, page 11)

Operation

Speedometer

The speedometer is a digital instrument with the appearance of an analog instrument. The speedometer is designed to be operated from a Faria® “paddle wheel” sensor.

A microprocessor controlled stepper motor moves the pointer to display boat speed using a linear dial.

The microprocessor and stepper motor provide excellent accuracy. Variations in the operation of the “paddle wheel” sensor are however fairly common. These variations may be caused by the mounting location of the “paddle wheel” on the hull which affects water flow characteristics or turbulence and air bubbles in the area of the “paddle wheel”. Therefore calibration of the speedometer may be required and is easily accomplished by using the Trip Log display or the pointer (see below).

The Commander™ has three push buttons: “Mode”, “Up”, and “Down”.

The “Mode” button is used to change the function of the LCD display and to access sub menus and adjustable settings.



The “Up” and “Down” buttons are used to modify the settings.



In the normal operation mode, pressing the “Mode” button for a short period of time causes the display to cycle between the Depth Sounder display and the Trip Log display.

Pressing and holding the “Mode” button causes the display to change to the

“settings” sub menu (see Figure 2).



When the settings menu have been selected, pressing the “Mode” button for a short period of time causes the display to cycle through the setting options. Within each setting selection, pressing the “Down” and “Up” buttons causes the affected setting to change.

Note: The microprocessor will automatically record the new settings as you adjust them.

When in a setting menu, *pressing and holding* the “Mode” button returns to the main function.



Lighting

In the normal operating mode the instrument lighting can be adjusted by pressing the “Up” and “Down” buttons.



The microprocessor will automatically record the new settings as you adjust them.

Trip Log



The Trip Log is similar to the trip odometer in an automobile. The distance traveled, as recorded by the speedometer “paddle wheel”, is displayed.



The Trip Log may be reset to zero, the units of measure changed, or the calibration adjusted using the sub menu.

Pressing and holding the “Mode” button while the Trip Log is displayed will change the display to the “settings” menu (see Figure 2).



Trip Log “Settings” Menu

There are three items in the Trip Log “Settings” Menu; Reset, Units, and Calibration.

Briefly press the “Mode” button will cycle through the menu items.



The microprocessor will automatically record the new settings as you adjust them.

Reset



Pressing the “Up” and “Down” button resets the Trip Log to zero.



Units



Pressing the “Up” or “Down” button cycles the units of measurement for the Trip Log between miles (MI) and nautical miles (NM)



Miles



Nautical Miles



Calibration



This menu item is used to simultaneously adjust the calibration of the Speedometer and the Trip Log. Two methods of calibration are possible. These methods will be discussed in the Calibration Section.

Depth Sounder

The Depth Sounder displays the depth of the water under the boat.



The depth can be displayed in feet, meters, or fathoms. Audible and visual alarms can be set to warn of shallow or deep water conditions. A “keel offset” setting allows the operator to adjust for the difference in the location of the Depth Sounder transducer compared to the deepest part of the boats hull.

The various settings are accessed by *pressing and holding* the “Mode” button

while the Depth Sounder is displayed (see Figure 2).



Depth Sounder “Settings” Menu

There are four items in the Depth Sounder “Settings” Menu; Shallow Alarm, Deep Alarm, Keel Offset, and Units.

Briefly pressing the “Mode” button cycles through the menu items.



The microprocessor will automatically record the new settings as you adjust them.

Shallow Alarm



Pressing the “Up” or “Down” button changes the setting for the Shallow Alarm.

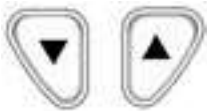

Setting the Shallow Alarm to zero turns off the alarm. To have this alarm indicate the depth of water under the deepest part of the hull, the Keel Offset must be properly set.

Deep Alarm



Pressing the “Up” or “Down” button changes the setting for the Deep Alarm. Setting the Deep Alarm to zero turns off the alarm.



Keel Offset



Pressing the “Up” or “Down” button changes the setting for the Keel Offset.



Negative numbers indicate that the Depth Sounder transducer is located ABOVE the deepest part of the hull (typical). Allow for worst case boat loading when adjusting the Keel Offset as this setting affects the Shallow Alarm.

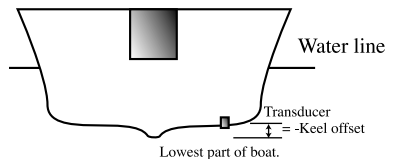

Units



Pressing the “Up” or “Down” button cycles the units of measurement for the Depth Sounder between feet (FT), meters (m), and fathoms (FA).



Feet



Quick press the “Mode” button two (2) times to enter the Calibrate “Settings menu”.

Meters



Fathoms



There are two methods of calibration;

1- A GPS or radar gun can be used to obtain a fixed speed. While holding the boat at the selected speed press the “Up” or “Down” buttons to adjust the speedometer pointer reading to match the GPS or radar gun indicated speed.



Loss of Signal

When the Commander loses signal from the transducer the LCD display will flash the following;



2- Reset the Trip Log to zero (See page 3) and then run a course of known distance, such as between two buoys or by using a GPS.

At the end of the run access the Calibration menu item.

Press the “Up” or “Down” buttons to adjust the recorded Trip Log distance to match the known distance. This will calibrate both Trip Log and the Speedometer.



Calibration

The Speedometer / Distance Traveled calibration is done in the Trip Log “settings menu”. (See Figure 2)

1. Enter the Trip Log

Press the “Mode” button to display the Trip Log.



2. Calibrate

Press and hold the “Mode” button to enter the settings menu.

(This page left blank intentionally.)

Figure 2 - Speedometer LCD Display Modes

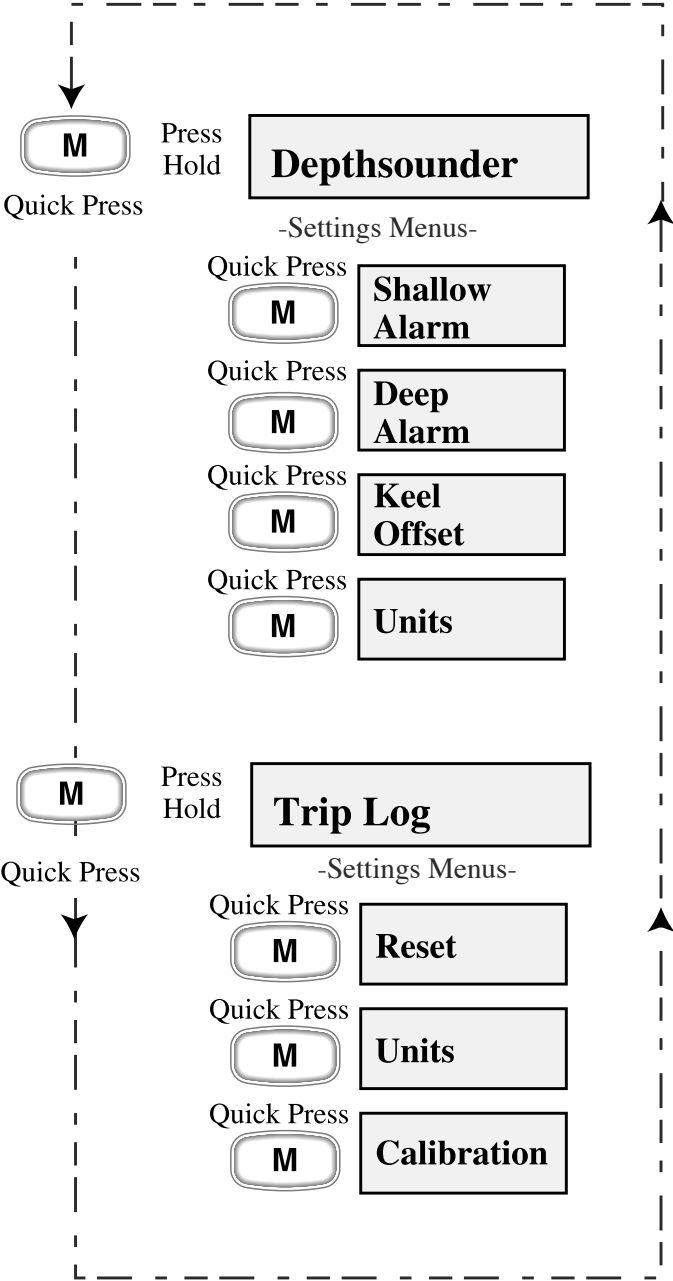

Setup Mode

The Speedometer full scale deflection setting can be changed using the Setup Mode (see Figure 3). Use this option only if you have reason to believe that your setting is wrong. Setting an incorrect value in this menu can result in extremely inaccurate performance of the speedometer.

To access the Setup Mode, *press and hold both* the “Up” and “Down” buttons while turning the ignition on.



The display will show “*SETUP*”.



Briefly pressing the “Mode” button will change the display to the setting menu.



The “Up” and “Down” buttons are used to modify the setting.



The microprocessor will automatically record the new setting as you modify it.

Pressing and holding the “Mode” button sets the instrument to normal operation.



Speedometer Full Scale Selection



Refer to Figure 3 for an explanation of each of the speedometer full scale selections.

This is normally a factory setting that needs no adjustment. The setting adjusts the “full scale” operating range of the speedometer to match the dial on the instrument. Using the “Up” and “Down” buttons, adjust the setting to match the maximum reading on the speedometer dial, 50 or 70 MPH.

Figure 3 SETUP MODE

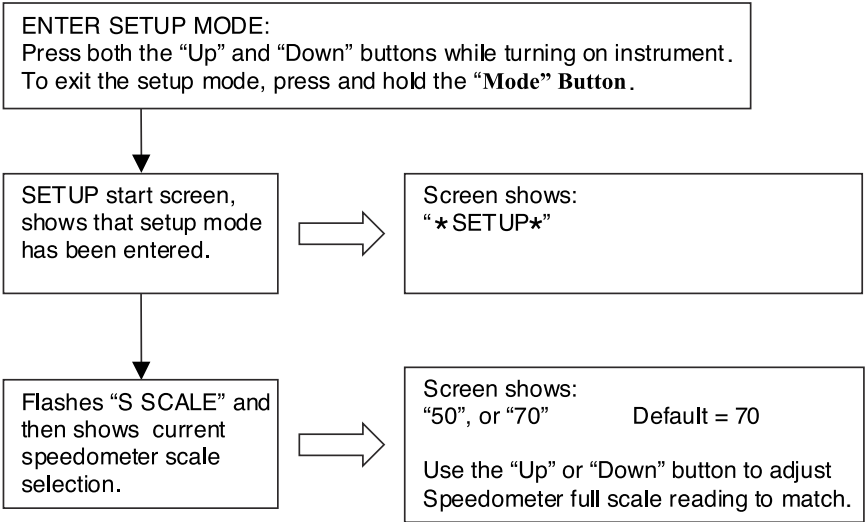

Figure 4 Power Connector p/n 990C0-86037

To Commander

Small Plug(CN0082)

Pin A	Gray	+14 Ignition Power
Pin B	Gray	+14 Ignition Power
Pin C	Black	Ground
Pin D	Green	Speedometer Input

HN1395 ECR 4652 6/1/04

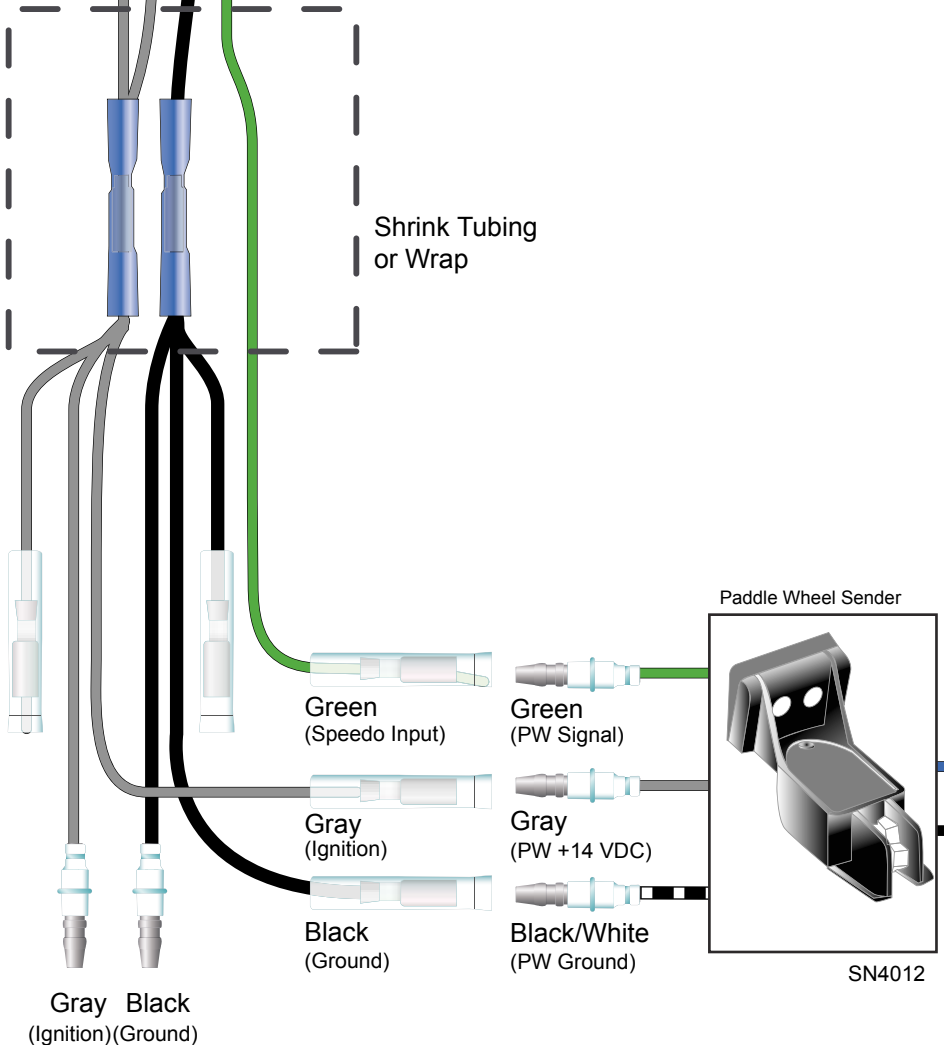
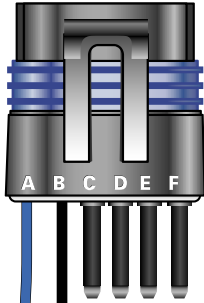

Figure 5

Depth Sounder Connector

p/n 990C0-86037

To Commander



Large Plug(CN0083)

Pin A	Blue	Depth Sounder (+) Sig
Pin B	Black	Depth Sounder (-) Sig
Pin C	Plug	Not Used
Pin D	Plug	Not Used
Pin C	Plug	Not Used
Pin D	Plug	Not Used

HN1395 ECR 4652 6/1/04

4x PJ0005

Blue



Black
(Ground)



Blue
(Depth
Sounder
(+) Signal)

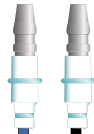

Black
(Depth
Sounder
(-) Signal)

