

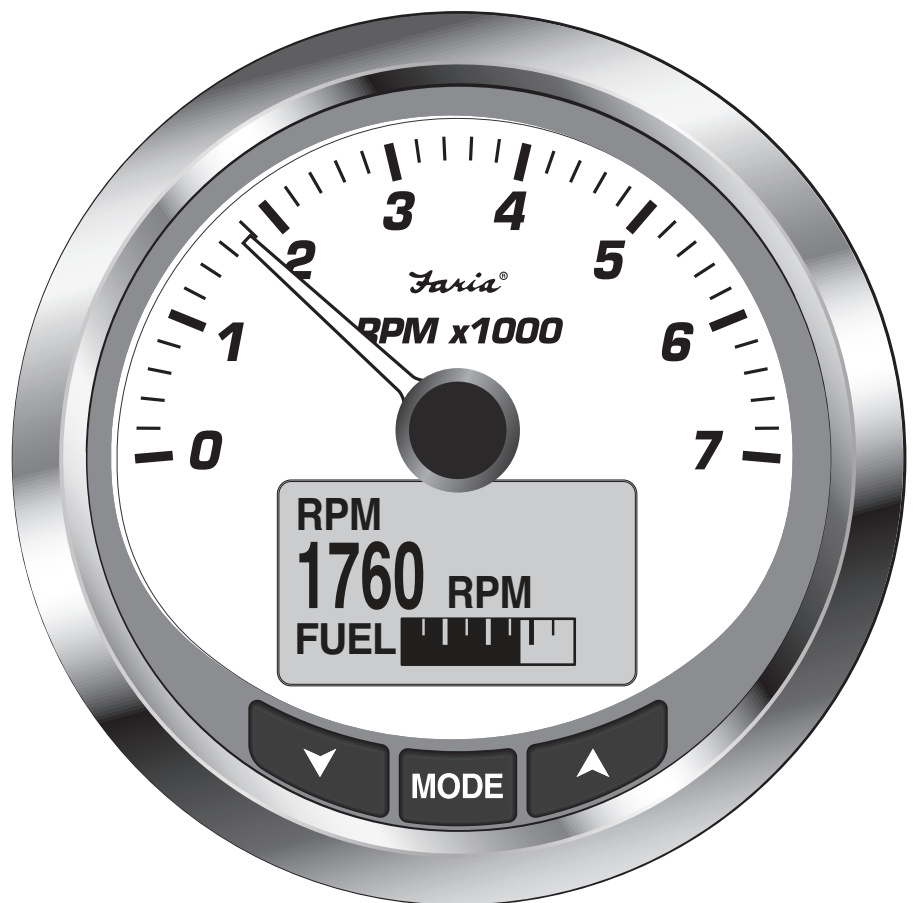

IS0307
rev. D 05/2016



MG3000 - Tachometer (SmartCraft™)

Installation / User Manual

www.FariaBeede.com

IMPORTANT: This User's Guide outlines the functionality and usage of the MG3000 tachometer. Before using the MG3000 tachometer, first read and understand ALL of the supplied product literature, as well as the boat's user's guide and outboard's operator's guide. This User's Guide should be stored onboard for reference at all times.

The photographs, illustrations and display screen used in this Guide might not depict actual models, figures, data fields, equipment or software versions, but are intended as representative views for the reference only. The continuing accuracy of this Guide cannot be guaranteed.

† SmartCraft is a regulated trademark of the Brunswick Corporation or its subsidiaries.

About This Guide

IMPORTANT: Read this User's Guide carefully before using the MG3000 digital instrumentation. This User's Guide should be kept onboard at all times during operation.

Need Assistance?

For any questions regarding the boat or outboard operation, please refer to the boat's user's guide, or outboard's operator's guide for support information.

For questions or problems regarding the MG3000 tachometer, contact your dealer.

IMPORTANT: This guide was written for the 4 inch MG3000 tachometer.

DATE	Rev.	DESCRIPTION	Program Version
10/10/12		Preliminary release	PGF370 Rev. X11C
12/13/12	Pre	Updates to program	PGF400_X06
04/26/2013	A	Release of manual	PGF400_X06
11/03/2013	B	Minor changes	
04/10/2014	C	Added SmartTow and OBD-M Fault light description	PGF460_A5
05/06/2016	D	See ECN 10362	PGF460 C

Gauges with other software versions may have features not documented in this guide. To view the gauge software version, refer to Software Version page 18.

Index

Installation 1
Wiring Diagram 2
Power On 3
System Setup 3
Select System Language. 3
Offset Settings. 3
Engine Initialization 3
Default Display Units 4
Tank Setup 4
Remaining Fuel Source 4
Number of Tanks 4
Set Type of Tank 4
Default Pages and Display Settings 5
Menu Options 6
Enter the Menu Options page 6
Reset Fuel Totalizer 6
Display Settings 7
Contrast Settings 7
Backlight Settings 7
Lighting Source 8
Fuel Level 8
Setting the Fuel Level. 8
Adding Fuel to the Fuel Tank 9
Trip Data 9
View Trip and Season Data 9
Resetting Trip and Season Data 9
Troll Control. 10
Turn Troll Control ON / OFF 10
Set Troll Control 10
Smart Tow (Cruise Control). 11
Turning ON/OFF 11
Set RPM 11
Launch Control 11
Building a Launch Profile. 12
Erasing a Launch Profile 14
Depth Warning. 15
Keel Offset 15
Shallow 15
Deep 15
OBD-M Fault Warning Light 16
Edit Menu 17
Appendix - System Menu 17
Initialization. 17
System Language 18
Audio Settings 18
Setting Saved Audio Setting. 18
Button Press Audio Setting 19
All Sounds. 19
Clock Settings. 19
Change Clock Data Type 20
Change Clock Time Offset 20
Alarms 20
Viewing Current Alarms 20
Clear Alarms. 20
Set Units. 21
Performing a Self Test 21

Software Version	22
Perform a Master Reset	22
Appendix - Fuel Set Up	23
Fuel Tank Setup	23
Setting the Fuel Level	23
Adding Fuel to the Tank	23
Setting the Tank Size	24
Calibrating the Fuel Sender	24
Low Fuel Warning Level	24
Fuel Totalizer	25
Reset the Fuel Totalizer	25
Appendix - Calibration	26
Calibrate Speedo	26
Calibrate Sender Transition	26
Calibrate Paddle Wheel sender	26
Calibrate Pitot sender	26
Calibrate Trim	27
Appendix - Max Speed	28
View Max Speed.	28
Resetting Max Speed	28
Appendix - Display Settings.	29
Setting the Number of Data Pages.	29
Screen Setup	29
Setting the Line 2 Data	29
Data Page Auto Scrolling Setting	30
Change the Auto Scrolling Interval Time	30
LCD Color	30
Appendix - Data Sources.	31
Tanks	31
Engine	31
Engine Maintenance Interval	32
Reset the Maintenance Interval	32
Engine ID	32
Remaining Fuel Source	33
Appendix - Pop up Messages	33
Turn Pop Up Alerts On or Off	33
Set Pop Up Alerts Threshold Value	33
Set Pop Up Alerts Duration	34
Trouble Shooting	35
Engine Warnings	35
Silence the Warning	35
Network Trouble shooting Chart	36
Abbreviations Used - Tachometer	36
Warning Buzzer	37
Default Functions Displayed in LCD by Engine Type	38
Program Map	39-41

Installation

Description

The MG3000 instruments use a “plug and play” networking technology based on SmartCraft data communication standards. These standards provide communications through a serial data network utilizing a Controller Area Network (CAN) integrate circuit (IC). The network allows multiple electronic devices to be connected together on a common channel for easy information sharing. Multiple digital displays can be used to monitor and broadcast equipment and engine data.

The MG3000 tachometer is controlled by a three-button keypad. The buttons and a brief description of their uses:

- UP and DOWN: Used to scroll through available pages in Normal Mode or options within the system menus.
- MODE: Used to access system menus, a short push of less than one second exits a menu and a long push of greater than one second makes a selection.

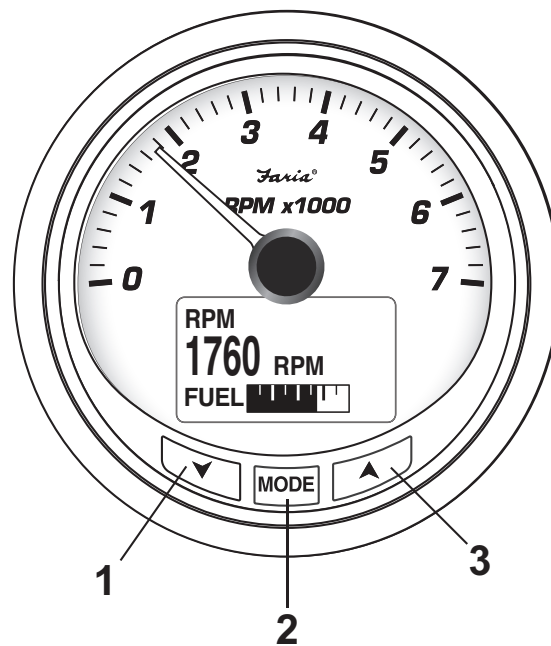

1. DOWN button
2. MODE button
3. UP button

Panel Thickness

Instruments can be mounted in panels up to 1" (13 mm) thick and in panels up to 1.5" with trimming the back clamp.

Hole Sizes

IMPORTANT: check space behind panel to be sure there is adequate clearance for instruments exists before drilling panel.

Cut a 3 3/8" (85 mm) diameter hole in the panel for the 4" instruments.

Cut a 4 3/8" (112 mm) diameter hole in the panel for the 5" instruments.

Attaching The Back Clamp

Insert instrument into the panel cut-out. Slide back clamp on gauge, place washer and finger tighten the nut (6-8 inch pounds), repeat for second stud.

MG3000 Wiring Diagram

Tachometer

Speedometer

Pitot connection for Speed.

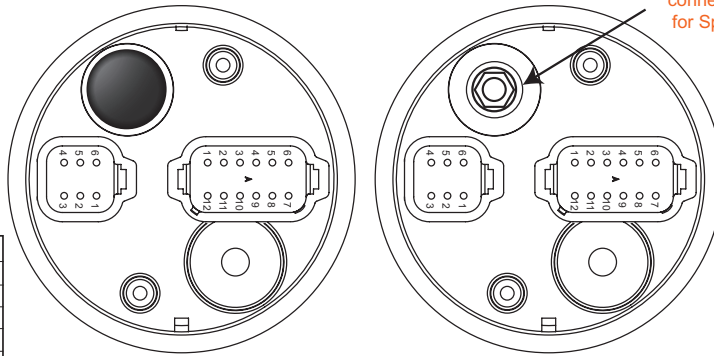

12- pin connector

Pin 1	7.7 vDC (Faria Bus +)
Pin 2	Faria Bus A
Pin 3	Faria Bus B
Pin 4	Ground
Pin 5	12VDC Ignition
Pin 6	Analog Input 1
Pin 7	Analog Input 2
Pin 8	Analog Input 3
Pin 9	N/C
Pin 10	• SmartCraft Ground
Pin 11	• SmartCraft 1+
Pin 12	• SmartCraft 1-

12- pin connector

Pin 1	7.7 vDC (Faria Bus +)
Pin 2	Faria Bus A
Pin 3	Faria Bus B
Pin 4	Ground
Pin 5	12 vDC Ignition
Pin 6	N/C
Pin 7	N/C
Pin 8	N/C
Pin 9	7.7 vDC (Faria Bus +)
Pin 10	Faria Bus A
Pin 11	Faria Bus B
Pin 12	Ground

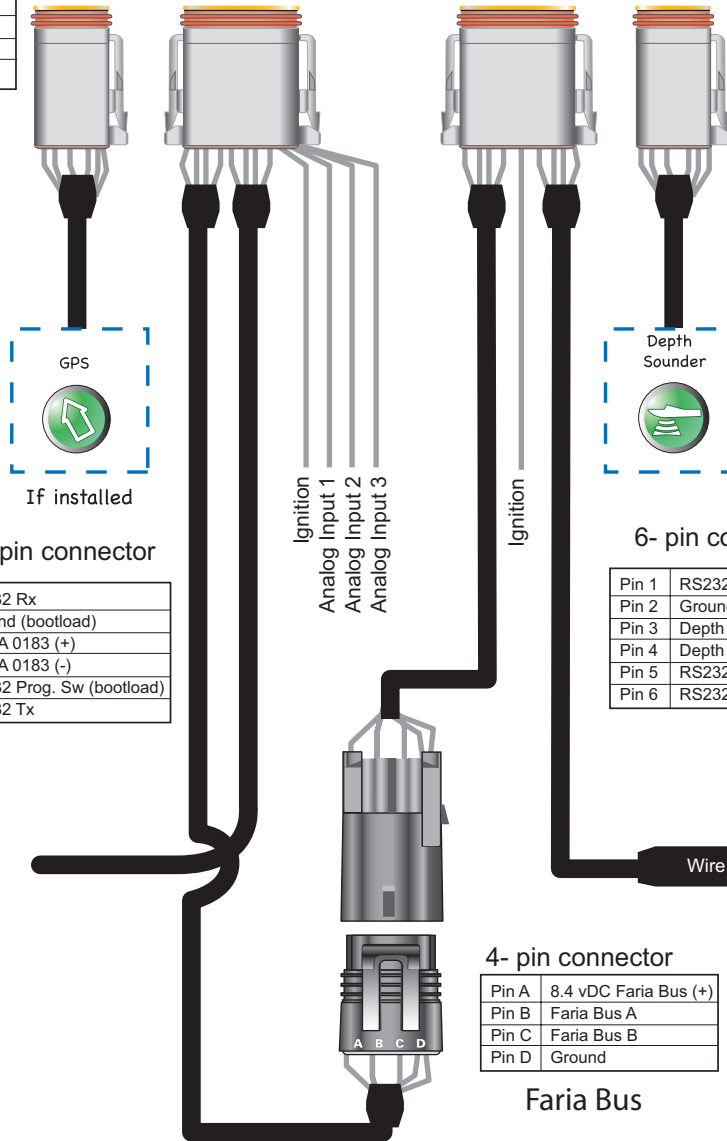

If installed

6- pin connector

Pin 1	RS232 Rx
Pin 2	Ground (bootload)
Pin 3	NMEA 0183 (+)
Pin 4	NMEA 0183 (-)
Pin 5	RS232 Prog. Sw (bootload)
Pin 6	RS232 Tx

6- pin connector

Pin 1	RS232 Rx
Pin 2	Ground (bootload)
Pin 3	Depth Signal (+)
Pin 4	Depth Signal (-)
Pin 5	RS232 Prog. Sw (bootload)
Pin 6	RS232 Tx

Multifunction Gauge

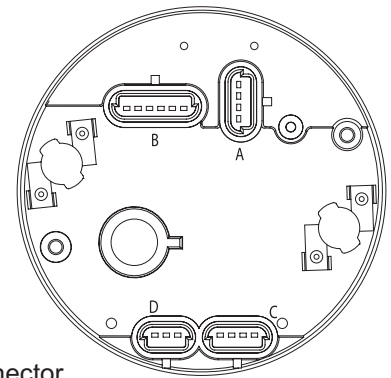

4- pin connector

Pin A	8.4 vDC Faria Bus (+)
Pin B	Faria Bus A
Pin C	Faria Bus B
Pin D	Ground

Information from the ECU

4- pin connector

Pin A	8.4 vDC Faria Bus (+)
Pin B	Faria Bus A
Pin C	Faria Bus B
Pin D	Ground

Faria Bus

Faria Bus
(To other gauges)

Power On

Turn the ignition key to the ON position. It is not required to start the engine for system initialization. The power on sequence for the tachometer and speedometer consists of a Self-Test which occurs at every power on event. The Self-Test process consists of the following steps:

- 1) At POWER ON the LCD screen displays the current software information and the MG3000 will cycle through several lighting variations.
- 2) All system pointers will sweep to full scale.
- 3) Then displays the SmartCraft Networked logo.
- 4) All system pointers will go to current value.

APP SELF TEST
SOFTWARE REV
PGF### X##
BUILD XXXX



When the Self-Test is complete, if the gauge displays data then the system initialization has already been completed. To customize the data displayed in the LCD go to Display Settings on page 29.

Otherwise, if this is the first time you have powered on your MG3000 tachometer, you will be prompted to System Setup. Complete the required system setup.

System Setup (Tachometer)

The tachometer initialization is required for the installed system to operate correctly. In order to complete the initialization process the user must select the default language, set the number of engines in the system, set the identifier of the engine to monitor, select the system default units and setup the fuel system information. The following sections describe the steps necessary to complete the tachometer initialization.

Select System Language

The first part of the initialization is selecting the language for the system.

- 1) Use the UP or DOWN buttons to select the desired language to be used. The available languages are: ENGLISH, SPANISH, FRENCH, ITALIAN and GERMAN.
- 2) Press and hold the MODE button to save the language selection. The LCD screen displays SETTING SAVED! along with an audible beep.

LANGUAGE
ENGLISH
SPANISH
ITALIAN

Clock Offset Settings

The Clock data field is available if a GPS is connected to the system. Select the current time zone offset for the Clock to show the correct time.

- 1) Use the UP or DOWN button to select the correct CLOCK OFFSET value.
- 2) Press and hold the MODE button to save the setting. The LCD screen displays SETTING SAVED! and the MG3000 issues an audible beep.

SELECT
CLOCK OFFSET
GMT
GMT +1

Once System Setup is completed and a GPS is connected to the MG3000 tachometer you can make further adjustment to the clock display. See Clock Settings, page 19.

Engine Initialization

- 1) Use the UP or DOWN buttons to select the number of engines installed on the

boat. The MG3000 tachometer supports up to 4 engines.

- 2) Press and hold the MODE to save the number of engines. The LCD screen displays SETTING SAVED! and the MG3000 issues an audible beep.

If more than one engine is installed continue to steps 3 and 4.

- 3) Use the UP and DOWN buttons to select the engine identifier. The engine identifier assigns each tachometer to monitor a specific engine.

The engine can be identified as either: PORT, STARBOARD, MID PORT and MID STARBOARD. If only one engine is identified the tachometer will automatically select the engine identifier and save.

- 4) Press and hold the MODE button to save the setting. The LCD screen displays SETTING SAVED! and the MG3000 issues an audible beep.

SET NUMBER
OF ENGINES
1
PRESS ▲ OR ▼

SET ENGINE ID
PORT
STARBOARD

Default Display Units

The default display units will set the units for all data fields in the instrument package. Using the advanced settings, the user can adjust individual data field's units to differ from the default units, see page 21 Set Units.

- 1) Use the UP or DOWN buttons to select the desired display units. Available display options are: US and EURO.
- 2) Press and hold the MODE button to save the selection. The LCD screen displays SETTING SAVED! and the MG3000 issues an audible beep.

ALL UNITS
US
EURO

Tank Setup

Important: All fuel tank information MUST be set up in the PORT tachometer if more than one MG3000 tachometer is in use.

Number of Tanks

- 1) Use the UP or DOWN buttons indicate the number of fuel tanks in the system. The MG3000 tachometer supports up to five (5) fuel tanks.
- 2) Press and hold the MODE button to save the selected number of fuel tanks. The LCD screen displays SETTING SAVED! and the MG3000 issues an audible beep.

SET NUMBER OF
TANKS
1
PRESS ▲ OR ▼

Set Type of Tank

For each tank indicated in the system the MG3000 tachometer will ask the type of tank used. Tank types available are OIL LEVEL, FRESH WATER, BAITWELL, BALLAST, GRAY WATER, BLACK WATER and FUEL.

- 1) Use the UP and/or DOWN buttons to select the type of tank in SET TANK # TYPE.
- 2) Press and hold the MODE button to save the selection.
- 3) Repeat steps 1 and 2 for the additional tanks.
- 4) When Tank Setup is complete, and all available tank types have been identified the tachometer's initialization is complete and the display will read "BASIC INITIALIZATION COMPLETE!". The MG3000 will perform a POWER ON Self Test and return to the Normal mode.

SET TANK #
TYPE
FUEL
OIL LEVEL

BASIC
INITIALIZATION
COMPLETE

Default Pages And Display Settings

When initialization for the tachometer is complete the MG3000 tachometer is ready for use. The tachometer's LCD display will show the default data page. Use the UP or DOWN buttons to scroll through the default display pages.

The default pages are shown below. In addition to these common screens each SmartCraft engine type has their own additional screens.

Common to all styles of engines

Break In - removed when time completed.

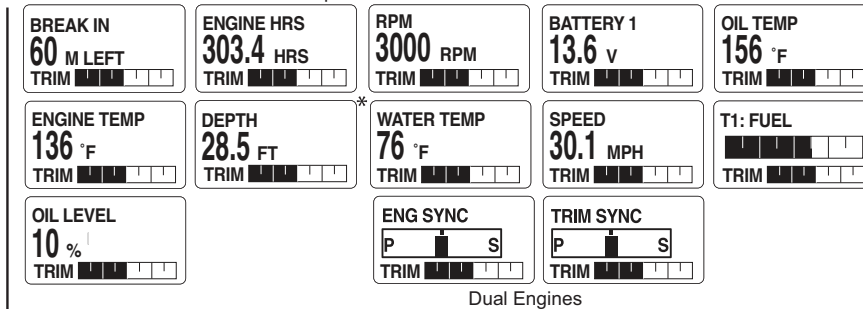

* Available only with SmartCraft Depth bus data.

2 Cycle Outboard - all common screens and add:



4 Cycle Outboard - all common screens and add:

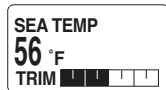

Inboard/Outboard and 4-cycle Inboards - all common screens and add:



Verado - all common screens and add:

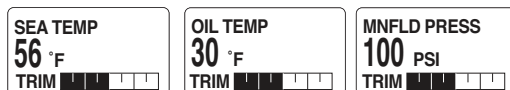

Diesel - all common screens and add:

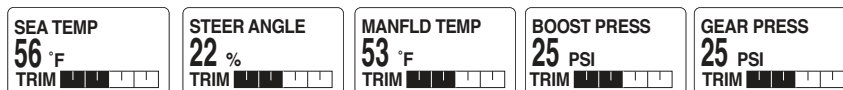

Jet Drive - all common screens and add:

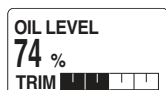

Troll Control



Use the UP and DOWN buttons together in the Normal mode for 1 second to enter TROLL mode.

Smart Tow



Use the UP and DOWN buttons together in the Normal mode for more than 1 second to enter "Smart Tow" mode.

Additional Screens

ENG SYNC	OIL PRESS
ENGINE LOAD	CLOCK
ENGINE HOURS	COG
EXHST TEMP	FRESH WATER
THROTTLE	FUEL ECON
TRIM	WATER PRESS
TRIM SYNC	WASTE WATER
FUEL LEVEL	FUEL USED
GPS SPEED (SOG)	FUEL PRESS
LATITUDE	FUEL FLOW
LONGITUDE	GEAR PRESS
RUDDER	BOOST PRESS
FUEL LEFT	MNFLD PRESS
FUEL INST	MNFLD TEMP
EST RANGE	SEASN HOURS
TRIP A HOURS	SEASN ODO
TRIP A ODO	SEASN FUEL
TRIP A FUEL	SEASN FAVG
TRIP A FAVG	TFUEL FLOW
TRIP B HOURS	TFUEL LEFT
TRIP B ODO	TFUEL INST
TRIP B FUEL	TFUEL USED
TRIP B FAVG	TFUEL AVG

Menu Options

While in Normal Mode, pressing the MODE button once will show the Tachometer Menu Options. The Tachometer Menu Options are:

- **RESET TOTALIZER:** Resets the total fuel used.
- **TRIP DATA:** records Engine Hours, Fuel Used, Odometer and Fuel Rate.
- **SMART TOW:** is used to operate the Smart Tow functions of your engine.
- **FUEL SETUP:** is used for quick access to add fuel to one of the fuel tanks.
- **EDIT MENU:** is used to make global Tachometer settings changes.
- **CONTRAST:** is used to adjust the Tachometer and Speedometer's display.
- **LIGHTING:** is used to adjust the lighting level(s).
- **DEPTH WARN:** is used to set the depth of the water alarms (if available)

For more information about the Menu Option look in the back of this manual in the Appendix section.

Note: Some functions may not be present in your version of the MG3000 program. Engine and Boat manufactures have the ability to customize the program to fit their build requirements. If you are looking for a feature listed in the Appendix and your MG does not show the function required please consult your Engine and Boat manufacturer's User manual.

Enter the Menu Options page.

- 1) Press the MODE button once to display the Menu Options.
- 2) Use the UP or DOWN buttons to select the desired menu option.
- 3) Press and hold the MODE button to enter the desired menu option.



Note: LIGHTING is available only if the source for LCD, DIAL or SYSTEM is set to INSTRUMENT.

To reset the Totalizer Fuel Used:

Reset Fuel Totalizer

The Fuel Totalizer is used when more than one Fuel Tank is installed in the system. The Totalizer will monitor all of the installed Fuel Tanks, gather the data and combine for fuel usage data that represents the entire system. The MG3000 automatically collects the fuel data based on the settings in the individual tank settings completed in SYSTEM SETUP. If you have not completed or wish to change the individual tank set up go to FUEL SETUP on page 19.

Use the Fuel Totalizer to monitor select TFUEL USED, TFUEL LEFT, TFUEL INST TFUEL FLOW or TFUEL AVG in the default pages.

TFUEL USED - Total Fuel Used - Displays the total amount of fuel used since the last reset.

TFUEL LEFT - Total Fuel Left - Displays the total amount of fuel left since last reset.

TFUEL INST - Total Instantaneous Fuel Flow - Measures how much fuel is flowing at

this time for all engines combined into one amount.

TFUEL AVG - Total Average Fuel Flow - Average of fuel flow from all engines taken over a period of time.

The only user selectable function in the Fuel Totalizer is the RESET TOTALIZER.

Warning: Resetting the totalizer will also reset all collected Fuel economy data.

To reset the Fuel Totalizer:

- 1) Press and hold the MODE button from the NORMAL mode.
- 2) Use the UP or DOWN buttons to select RESET TOTLIZR.
- 3) When prompted, TOTALIZER RESET? use the UP or DOWN buttons to select YES to reset the totalizer fuel used, or select NO to exit.
- 4) Press and hold the MODE button to save the setting. The LCD screen displays SETTING SAVED! and the MG3000 issues an audible beep.

HOLD MODE
TO ENTER
RESET TOTLIZR
TRIP DATA

TOTALIZER
RESET?
NO
YES

Display Settings

Adjusting the display settings may improve visibility.

- 1) Press the MODE button once to view the menu options.
- 2) Press the UP or DOWN buttons to select LIGHTING or CONTRAST.
- 3) Press and hold MODE to make the selection.
 - To adjust the contrast in the tachometer and speedometer (if connected) display, go to Step 4.
 - To adjust the tachometer's backlight intensity, go to Backlight Settings.

HOLD MODE
TO ENTER
CONTRAST
LIGHTING

Contrast Settings

There are 22 defined contrast levels. The contrast level will change to negative mode, white font on dark background, halfway through the 22 predefined contrast settings.

- 4) Press the UP button to increase or the DOWN button to decrease the contrast level in the LCD display.
- 5) The contrast setting is automatically saved to the tachometer and synchronized to all gauges linked to the MG3000

ADJUST
LCD
CONTRAST
PRESS ▼ OR ▲

ADJUST
LCD
CONTRAST
PRESS ▼ OR ▲

Backlight Settings

By default the Dial Backlight (all gauges connected to the MG3000 tachometer) and the Display Backlight (tachometer and speedometer LCD) are synchronized, they get brighter or dimmer at the same time. Use the MG3000 tachometer to adjust the lighting options. Enter the menu options, then:

- 1 Use the UP or DOWN button to select the LIGHTING to adjust.
- 2) Press and hold the MODE button to make the selection.
- 3) Use the UP or DOWN button to select the lighting level to adjust.

From the MG3000 tachometer you can adjust the tachometer LCD lighting and Dial

HOLD MODE
TO ENTER
LIGHTING
EDIT MENU

LIGHTING
ADJUST DIAL
ADJUST SYSTEM
SOURCE

lighting and the System lighting, which will adjust all instruments connected to the tachometer.

- 4) Press and hold the MODE button to make the selection.
- 5) Use the UP button to increase the lighting intensity or press the DOWN button to dim the lighting intensity.
- 6) Press and hold the MODE button to save the setting. The LCD screen displays SETTING SAVED! and the MG3000 issues an audible beep.

**ADJUST DIAL
BRIGHTNESS
100 %
PRESS ▼ OR ▲**

Lighting Source

Note: The LIGHTING adjustment at the tachometer is only available if the source for LCD, DIAL or SYSTEM is set to INSTRUMENT.

- 1) Use the UP and/or DOWN buttons to select SOURCE.
- 2) Press and hold the MODE button to enter the selection.
- 3) Use the UP or DOWN button to make the selection.
- 4) Press and hold the MODE button to save the setting. The LCD screen displays SETTING SAVED! and the MG3000 issues an audible beep.

**LIGHTING
SOURCE
SYSTEM
CONTROL**

**SOURCE
BUS DATA
INSTRUMENT
ANALOG #1 P1-6**

Fuel Level

Use FUEL LEVEL to quickly add fuel amounts to each fuel tank and set the tank indicator FULL after a fuel fill up. By keeping accurate accounts of the fuel added to the tanks at fill up the MG3000 tachometer can help you by calculating accurate fuel economy values such as Fuel Flow, Range and Trip data.

Enter the Menu options then:

- 1) Use the UP or DOWN buttons to select FUEL LEVEL.
- 2) Press and hold the MODE button to make the selection.
- 3) Use the UP or DOWN buttons to select the fuel tank to make an adjustment to.
- 4) Press and hold the MODE button to enter the selection.
- 5) Follow the steps in the next sections.

**SELECT TANK TO
ADD FUEL TO
T:1 FUEL
T:2 FUEL**

Setting The Fuel Level

Setting the Fuel Level in the MG3000 tachometer is performed in the PORT tachometer if more than one MG3000 tachometer is in use. To set the fuel level to full, enter the FUEL LEVEL menu, then:

- 1) Use the UP or DOWN buttons to select SET FULL.
- 2) Press and hold the MODE button to set fuel tank to FULL.
- 3) At prompt, SET TANK FULL, use the UP or DOWN buttons to select YES, the fuel tank is indicating full, or NO to return to the SET FULL menu.

**T#: FUEL
SET FULL
ADD FUEL**

**SET TANK FULL
NO
YES**

Note: A full indication indicates that the amount of fuel added to the fuel tank is equal to the capacity of the fuel tank set up in the initialization setup. The MG3000 uses this number to calculate the Fuel economy calculations. An inaccuracy in this number will

result in faulty calculations.

- 4) Use the MODE button to make the selection.

If YES was selected the LCD screen will display SETTING SAVED! and then return you to the SET FULL menu.

Adding Fuel to the Fuel Tank:

- 1) Use the UP or DOWN buttons to select ADD FUEL
- 2) Press and hold the MODE button to enter the TANK # ADD menu.
- 3) Use the UP or DOWN buttons to set the volume of Fuel that has been added to the fuel tank.
- 4) Press and hold the MODE button to save the setting. The LCD screen displays SETTING SAVED! and the MG3000 issues an audible beep.

Note: Holding the UP or DOWN button will increase or decrease the amount in a more rapid fashion.

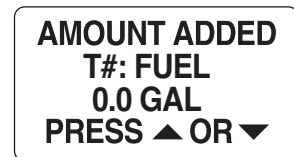

Trip Data

The Trip Data feature records ENGINE HOURS, FUEL USED, ODOMETER and FUEL RATE for two trips and the season. To view the Trip Data enter the Menu options, then:

- 1) Use the UP or DOWN buttons to select TRIP DATA
- 2) Press and hold the MODE button to enter the selection.
- 3) Follow the steps in the next sections.



View Trip and Season Data

- 1) Use the UP or DOWN buttons to select TRIP A, TRIP B or SEASON.
- 2) Press and hold the MODE button to enter the selection.
- 3) Use the UP or DOWN buttons to select VIEW DATA.
- 4) Press and hold the MODE button to make a selection.
- 5) Use the UP or DOWN buttons to select information to be shown.

Note: Available Trip information is; Engine Hours, Fuel Used, Distance and Fuel Rate.

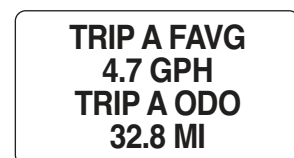

Resetting Trip and Season Data

- 1) Use the UP or DOWN buttons to select TRIP A, TRIP B, or SEASON.
- 2) Press and hold the MODE button to enter the selection.
- 3) Use the UP or DOWN buttons to select RESET DATA.
- 4) Press and hold the MODE button.

At the prompt: RESET DATA?

- 5) Use the UP or DOWN buttons to select YES to reset the data, or select NO to exit.



- 6) Press and hold the MODE button to reset the data. The LCD screen displays SETTING SAVED! and the MG3000 issues an audible beep.

Troll Control

The “Troll Control” function allows the operator to set the engine RPM and have the engine maintain the RPM setting automatically. Troll Control is not available on systems with DTS (Digital Throttle and Shift) features. (See SmartTow page 11)

The upper and lower limits for these functions are preset in the engine ECU and can not be changed by the operator. For the troll control function to operate the engine control MUST be “In Gear” and at “Idle”.

When Troll Control is active a persistent icon will be turned on. The icon, a “T” will show in the upper right hand corner of the display.

Turn Troll Control ON / OFF

To view the Troll Control enter the Menu options, then:

- 1) Use the UP or DOWN buttons to select TROLL CONTROL
- 2) Press and hold the MODE button to enter the selection.

Note: A short cut has been built into the software to enter the TROLL CONTROL. Press and hold the UP and DOWN buttons together for longer than 1 second. You can do this from any screen and you will be taken directly into the TROLL CONTROL menu.

- 3) Use the MODE button to select ON to turn on TROLL CONTROL or OFF to turn control off.

Note: The engine control must be “In Gear” and set to “Idle” for the troll control to function. The “PLEASE MAKE SURE ENGINE IS IN GEAR” or “PLEASE MAKE SURE ENGINE IS IN IDLE” (not shown) screens will appear if these conditions have not been met. Troll Control requires engine support; please make sure a Mercury® SmartCraft™ engine with the Troll function has been installed.

- 4) Use the UP or DOWN buttons to set the RPM value to maintain while trolling.

There is no manual way to return to the “Normal” mode from the “Toll Control” mode, if no buttons are pressed for 15 seconds the unit will automatically return to the “Normal” mode. Troll control will continue to work until you manually turn it off.

- 5) TROLL CONTROL WILL DISENGAGE if the engine is returned to NEUTRAL or if the throttle is moved beyond the idle mode.

When the Troll Control is on, the warning LED’s will flash once every 20 seconds. This indicates that the Troll Control is active.

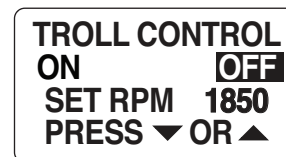
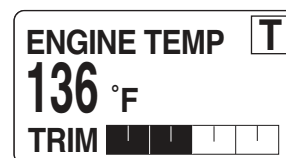

SmartTow (Not available on all systems)

SmartTow is a SmartCraft system that allows you to select from five Launch Control profiles to set your pull intensity and RPM to automatically adjust the speed of the boat using the RPM of the engine. SmartTow is available for engines that have the DTS (Digital Throttle and Shift) features installed.

If available and engaged a persistent icon will display a “S” in the upper right hand corner of the display.

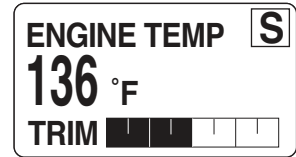

Turning Cruise Control ON/OFF

The Cruise Control (SmartTow) can be turned ON from any screen in the MG3000 tachometer.

- 1) Press and hold the UP and DOWN buttons together for more than 1 second.



The Cruise Control (SmartTow) can be turned OFF from any screen in the MG3000 tachometer.

- 1) With Cruise Control ON. Press and Hold the UP and DOWN buttons together for more than 1 second.



SmartTow Options

To enter the SMART TOW menu enter the Menu options then;

- 1) Press the UP or DOWN buttons to select SMART TOW.
- 2) Press and hold MODE to make the selection.



Set RPM

- 1) Press the MODE button quickly to select SET RPM.
- 2) Use the UP or DOWN buttons to select the desired RPM.
- 3) Press the MODE button to save the selection.
- 4) Press the MODE button again to exit out of Cruise Control.



Launch Control

Pre-set Launch Settings

There are five built in or manufacturer set Launch Control profiles and 8 user set profiles.

Profile 1: Whether you're trolling through a no-wake channel or pulling a first-time skier, Smart Tow will keep your speed where you want it. This setting gradually takes you from idle to your desired speed.

Profile 2: This setting allows even the most accomplished wakeboarder to feel as if they are being pulled by an expert driver. This setting also offers tubers the perfect mix of gradual plane. They'll have the time of their lives.

Profile 3: The intensity out of the hole is hotter and the overshoot past the RPM set-point is a little higher. The outcome is a pull that will allow the accomplished wakeboarder a true thrill.

Profile 4: Provides a fairly aggressive hole shot and longer overshoot. And coupled with the skier's desired RPM, it provides a perfect, consistent pull every time.

Profile 5: No worries. With SmartTow, you'll have both hands available, and you'll provide the perfect hole shot for an experienced slalom skier.

To select one of the five pre-set profiles;

- 1) Press the MODE button quickly to select SET LAUNCH.
- 2) Use the UP or DOWN buttons to select the desired LAUNCH pre-set.
- 3) Press the MODE button to save the selection.
- 4) Press the MODE button again to exit out of Cruise Control.

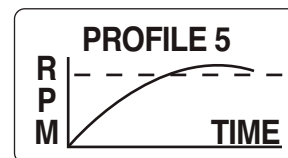

Custom Launch Settings

The operator can customize up to eight custom profiles. The LCD display will indicate the 5 Default pre-set profiles. Beyond the 5 pre-set profiles the LCD will display the customized profiles. The first three letters of the profile are shown. If no customized profiles are available the LCD displays NEW.

- 1) Press the MODE button quickly to select SET LAUNCH.
- 2) Use the UP or DOWN buttons to select the desired LAUNCH profile.
- 3) Press the MODE button to save the selection.
- 4) Press the MODE button again to exit out of Cruise Control.



Building a Launch Profile

Each customized launch setting name can have up to seven alpha characters to identify the custom launch. The custom launch setting can be controlled by RPM. To build a customized Launch Profile enter the SET LAUNCH mode;

- 1) Press the MODE button quickly to select SET LAUNCH.
- 2) Use the UP or DOWN buttons to select NEW.
- 3) Press the MODE button to save the selection.



To create a profile the operator will need to set five profile characteristics; NAME, RPM SET, LAUNCH, OVERSHOOT and DURATION.

Name

- 1) Press and hold the MODE button for more than 1 second.
- 2) Use the UP or DOWN buttons to select NAME.
- 3) Press and hold the MODE button for more than 1 second.
- 4) Use the UP and DOWN buttons to select the first letter in the profile name.
- 5) Press and hold the MODE button for greater than 1 second to save the selection.
- 6) The pointer moves to the next letter. There are 9 character spaces available.
- 7) Press and hold the MODE button to save the setting. The LCD screen displays SETTING SAVED! and the MG3000 issues an audible beep.



RPM Set

- 1) Press and hold the MODE button for more than 1 second.
- 2) Use the UP or DOWN buttons to select RPM.
- 3) Press and hold the MODE button for more than 1 second.
- 4) Use the UP and DOWN buttons to select the first number in the profile RPM.
- 5) Press and hold the MODE button for greater than 1 second to save the selection.
- 6) The pointer moves to the next number.
- 7) Press and hold the MODE button to save the setting. The LCD screen displays SETTING SAVED! and the MG3000 issues an audible beep.

EDIT PROFILE
RPM SET
LAUNCH
OVERSHOOT

RPM SET
 ▲
1000
 ▼

Launch Set

Adjusts the level of acceleration applied once SmartTow is activated.

- 1) Press and hold the MODE button for more than 1 second.
- 2) Use the UP or DOWN buttons to select LAUNCH.
- 3) Press and hold the MODE button for more than 1 second.
- 4) Use the UP and DOWN buttons to select the first number in the profile LAUNCH.
Select between a value of 1.0 and 5.0. Higher values indicate increased acceleration.
- 5) Press and hold the MODE button for greater than 1 second to save the selection.
- 6) The pointer moves to the next number.
- 7) Press and hold the MODE button to save the setting. The LCD screen displays SETTING SAVED! and the MG3000 issues an audible beep.

EDIT PROFILE
LAUNCH
OVERSHOOT
DURATION

LAUNCH
 ▲
05.0
 ▼

Overshoot Percentage

Sets the amount of RPMs by percentage that the engine is allowed to over rev to adjust while compensating for drag.

- 1) Press and hold the MODE button for more than 1 second.
- 2) Use the UP or DOWN buttons to select OVERSHOOT.
- 3) Press and hold the MODE button for more than 1 second.
- 4) Use the UP and DOWN buttons to select the first number in the profile OVERSHOOT.

EDIT PROFILE
OVERSHOOT
DURATION
ERASE PROFILE

Adjust the percentage of OVERSHOOT from 0 to 20%.

- 5) Press and hold the MODE button for greater than 1 second to save the selection.
- 6) The pointer moves to the next number.
- 7) Repeat for the second number.
- 8) Press and hold the MODE button to save the setting. The LCD screen displays SETTING SAVED! and the MG3000 issues an audible beep.

OVERSHOOT %
 ▲
12
 ▼

Duration

The Duration is used to set the number of seconds the overshoot percentage is activated.

- 1) Press and hold the MODE button for more than 1 second.
- 2) Use the UP or DOWN buttons to select DURATION.
- 3) Press and hold the MODE button for more than 1 second.
- 4) Use the UP and DOWN buttons to select the first number in the profile DURATION..

The number of seconds can be set from 0 to 4.

- 5) Press and hold the MODE button for greater than 1 second to save the selection.
- 6) Repeat for the second number.
- 7) Press and hold the MODE button to save the setting. The LCD screen displays SETTING SAVED! and the MG3000 issues an audible beep.

EDIT PROFILE
DURATION
ERASE PROFILE
NAME

DURATION - SEC
▲
2.0
▼

Erasing a Launch Profile

Each customized launch profile can be erased out of the system. To delete a customized profile, enter the Menu options then;

- 1) Use the UP or DOWN buttons to select SMART TOW.
- 2) Press and hold MODE to make the selection.
- 3) Press the MODE button quickly to select SET LAUNCH.
- 4) Use the UP or DOWN buttons to select the customized profile you wish to delete.
- 5) Press the MODE button to make the selection.
- 6) Use the UP or DOWN buttons to select ERASE PROFILE.
- 7) Press and hold the MODE button for more than 1 second.

HOLD MODE
TO ENTER
SMART TOW
FUEL SETUP

1300  **5**
SET **SET**
RPM **LAUNCH**

EDIT PROFILE
ERASE PROFILE
NAME
RPM SET

You will be asked if you want to ERASE PROFILE. NO is the default setting.

- 8) If YES, use the UP or DOWN button to select YES. If NO, use the UP or DOWN buttons to select NO. If no selection is made the MG will return to the ERASE PROFILE page and no setting will be saved.
- 9) Press and hold the MODE button to save the setting. The LCD screen displays SETTING SAVED! and the MG3000 issues an audible beep.

ERASE
PROFILE?
YES
NO

Depth Warnings

Lets the user know when the water below the transducer as received from the SmartCraft bus is above or below the threshold for alarms. The user can set these alarms for shallow water and deep water.

To enter the DEPTH WARN menu enter the Menu options then;

- 1) Press the UP or DOWN buttons to select DEPTH WARN.
- 2) Press and hold MODE to make the selection.

HOLD MODE
TO ENTER
DEPTH WARN
RESET TOTLIZR

Keel Offset

When setting the Keel Offset, negative numbers indicate that the Depth Dounder transducer is located ABOVE the deepest part of the hull (typical). Allow for worst case boat loading when adjusting the Keel Offset as this setting affects the Shallow Alarm.

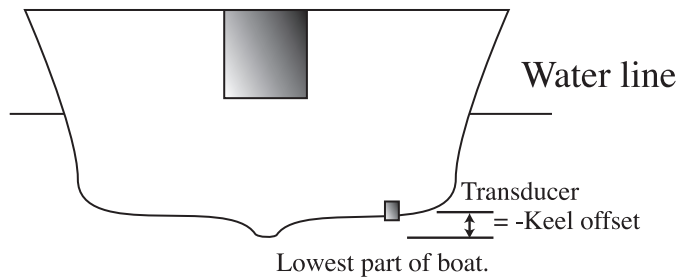

- 1) Use the UP or DOWN buttons to select the KEEL OFFSET.
- 2) Press the MODE button to make the selection.
- 3) Use the UP or DOWN buttons to set the offset.
- 4) Use the MODE button to save the setting. The LCD screen displays SETTING SAVED! and the MG3000 issues an audible beep.

DEPTH WARN
KEEL OFFSET
SHALLOW WTR
DEEP WATER

SET
KEEL OFFSET
1.0FT
PRESS ▲ OR ▼

DEPTH WARN
SHALLOW WTR
DEEP WATER
KEEL OFFSET

Shallow Water

- 1) Use the UP or DOWN buttons to select the SHALLOW WTR menu.
- 2) Press the MODE button to make the selection.
- 3) Use the UP or DOWN buttons to set the "Shallow Water" depth setting.
- 4) Press the MODE button to save the setting. The LCD screen displays SETTING SAVED! and the MG3000 issues an audible beep.

DEPTH WARN
SHALLOW WTR
1.0FT
PRESS ▲ OR ▼

DEPTH WARN
DEEP WATER
KEEL OFFSET
SHALLOW WTR

Deep Water

- 1) Use the UP or DOWN buttons to select the DEEP WATER menu.
- 2) Press the MODE button to make the selection.
- 3) Use the UP or DOWN buttons to set the "Deep Water" depth setting.
- 4) Press the MODE button to save the setting. The LCD screen displays SETTING SAVED! and the MG3000 issues an audible beep.

DEPTH WARN
DEEP WATER
1.0FT
PRESS ▲ OR ▼

OBD-M Fault Light

Boats powered by Emissions Control Technology (ECT) catalyzed engines must be equipped with a SmartCraft-enabled gauge capable of displaying the service engine icon.

The service engine icon of MIL provides a visual indication of a malfunction with the engine's emission control system and remain illuminated while the OBD-M fault is active.

If the OBD-M fault should occur the MG3000 LCD display will indicate the check engine icon and the LCD will change color to AMBER letting the operator know of the OBD-M fault.

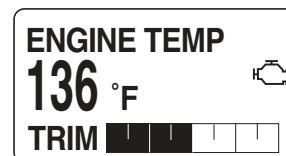

Edit Menu

While in Normal Mode, pressing the MODE button once will show the Menu Options. Scroll until EDIT MENU is highlighted, then hold the MODE button to enter. A brief description of the Edit Menu options follows:

- **SYSTEM:** is used to make global tachometer changes for Audio, perform a Self-Test or Master Reset and view the Software version.
- **CAL SPEEDO:** Used to calibrate the Paddlewheel and Pitot senders to a known reference source.
- **CAL TRIM:** Calibrates the trim sender.
- **FUEL SETUP:** is used to set and manage the fuel devices.
- **DISPLAY:** is used to edit the data pages that are shown in Normal Mode as well as adjust lighting and contrast.
- **DATA SOURCES:** is used to select the data sources for Engine parameters, battery, oil sender and analog inputs.
- **POP UP ALERTS:** is used to set user definable information pop ups when changes occur in a monitored data value.
- **CUSTOM ALARMS:** is used to set special pop up alerts in the MG3000.
- **MAX SPEED:** The MG3000 tachometer records the highest speed during the last period since reset.

Note: Although the manual may identify a particular function as being part of the MG3000 architecture individual functions may not be available for your installation. Check with your engine and boat manufacturer for function availability.

System

Use the SYSTEM edit menu to initialize the tachometer, set the system language, control the Audio settings, perform a Self-Test or Master Reset and to view the current software version for the tachometer. Follow the steps below to view the SYSTEM edit menu options.

- 1) Press the MODE button once.
- 2) Use the UP and/or DOWN buttons to select EDIT MENU.
- 3) Press and hold the MODE to enter the EDIT MENU options.
- 4) Use the UP and/or DOWN buttons to select SYSTEM.
- 5) Press and hold the MODE button to make the selection.



Initialization

When the MG3000 tachometer is first powered on the MG3000 goes into the INITIALIZATION mode.

If you wish to initialize the tachometer after the initial set up was completed, ENTER SYSTEM menu then:

- 1) Use the UP or DOWN buttons to select INITIALIZE.
- 2) Press and hold the MODE button to make selection.
- 3) Use the UP or DOWN buttons to select YES to initialize or NO to return to the



EDIT menu.

- 4) Press and hold the MODE button to make selection.

To complete the initialization process select the default language, set the number of engines in the system, set the identifier of the engine to monitor, select the system default units and setup the fuel system information.

If the MG3000 tachometer has not been initialized previously when the power is first applied the tachometer will automatically start up into the INITIALIZATION mode. See System setup on page 2.

**ENTER
INITIALIZATION**
YES
NO

System Language

Enter the SYSTEM menu then:

- 1) Use the UP or DOWN button to select LANGUAGE.
- 2) Press and hold the MODE button to make the selection.
- 3) Use the UP or DOWN buttons to select the desired language to be used. The available languages are: ENGLISH, SPANISH, FRENCH, ITALIAN and GERMAN.
- 4) Press and hold the MODE button to save the language selection. The LCD screen displays SETTING SAVED! along with an audible beep.

LANGUAGE
ENGLISH
SPANISH
ITALIAN

Audio Settings

The Audio menu is used to turn on or off the buzzer. To make changes to the system audio enter the SYSTEM menu and then:

- 1) Use the UP or DOWN buttons to select AUDIO options.
- 2) Press and hold the MODE button to make the selection.
- 3) Use the UP or DOWN buttons to select the desired menu.
- 4) Press and hold the MODE button to make the selection.

SYSTEM INFO
AUDIO
CLOCK SETTING
SET UNITS

Setting Saved Audio Setting

Use SET SAVED to turn the buzzer ON or OFF after a setting is saved in the tachometer.

To change the setting enter the SYSTEM menu, then:

- 1) Use the UP or DOWN buttons to select the SET SAVED.
- 2) Press and hold the MODE button to enter the selection.
- 3) When prompted, select the SETTING SAVED AUDIO STATUS. Use ON to have the tachometer beep when saving a setting, or OFF to turn off the beep and return to the AUDIO options menu.
- 4) Press and hold the MODE button to save the setting. The LCD screen displays SETTING SAVED! and the MG3000 issues an audible beep.

AUDIO SETTING
SET SAVED
BUTTON PRESS
ALL

SETTING SAVED
AUDIO STATUS
ON
OFF

Button Press Audio Setting

Use BUTTON PRESS to turn the buzzer on or off whenever a button is pressed on the tachometer.

Enter the SYSTEM menu then:

- 1) Use the UP or DOWN buttons to select the BUTTON PRESS.
- 2) Press and hold the MODE button to enter the selection.
- 3) When prompted, select the BUTTON PRESS AUDIO STATUS. Use ON to have the tachometer beep after every button press, or OFF to turn off the beep and return to the AUDIO options menu.
- 4) Press and hold the MODE button to save the setting. The LCD screen displays SETTING SAVED! and the MG3000 issues an audible beep.

AUDIO SETTING
BUTTON PRESS
ALL
SET SAVED

BUTTON PRESS
AUDIO STATUS
ON
OFF

All Sounds

Use ALL to turn the buzzer ON or OFF for ALL the Audio menu options.

Enter the SYSTEM menu then:

- 1) Use the UP or DOWN buttons to select the ALL
- 2) Press and hold the MODE button to enter the selection.
- 3) When prompted, select the ALL BEEPS AUDIO STATUS. Use ON to have the tachometer beep for all audio feedback or OFF to turn off the beep and return to the AUDIO options menu.
- 4) Press and hold the MODE button to save the setting. The LCD screen displays SETTING SAVED! and the MG3000 issues an audible beep.

AUDIO SETTING
ALL
SET SAVED
BUTTON PRESS

ALL BEEPS
AUDIO STATUS
ON
OFF

Clock Settings

You will be asked to select the current time zone offset for the Clock to show the correct time in the INITIALIZATION mode when you first start the MG3000. **The Clock data field is available only if a GPS is connected to the system.** Clock data can be shown using a 12 or 24 hour format.

SYSTEM INFO
CLOCK SETTING
SET UNITS
SELF-TEST

To set the Clock, enter the SYSTEM menu, then:

- 1) Use the UP or DOWN buttons to select CLOCK SETTING.
- 2) Press and hold the MODE button to enter the selection.

To change the Clock Data Type:

- 3) Use the UP and/or DOWN buttons to select TYPE.
- 4) Press and hold the MODE button to enter the selection.
- 5) Use the UP or DOWN button to select 12 HOUR or 24 HOUR time format.
- 6) Press and hold the MODE button to save the selection. The LCD screen displays SETTING SAVED! and the MG3000 issues an audible beep.



SET CLOCK
DISPLAY TYPE
12 HOURS
24 HOURS

To change the time offset:

- 1) Use the UP and/or DOWN buttons to select TIME OFFSET.
- 2) Press and hold the MODE button to enter the selection.
- 3) Use the UP or DOWN button to select the correct TIME OFFSET value.
- 4) Hold the MODE button to save the selection. The LCD screen displays SETTING SAVED! and the MG3000 issues an audible beep.



SELECT
CLOCK OFFSET
GMT
GMT +1

Alarms

The MG3000 digital gauge package is equipped with an ALARMS menu that enables the user to view current and past alarms.

Viewing Current Alarms

To view the current alarms enter the SYSTEM menu, then:

- 1) Use the UP or DOWN buttons to select ALARMS.
- 2) Press and hold the MODE button to enter the selection.
- 3) Use the UP or DOWN buttons to highlight VIEW.
- 4) Press and hold the MODE button to make the selection.



ALARMS
VIEW
CLEAR

If there are current alarms, the screen will show the first alarm. Use the UP or DOWN buttons to view all alarms. When finished, press the MODE button to escape.

Note: Date information is only available if a SmartCraft GPS antenna is in the system.

If there are no current alarms, the screen will display NO STORED ALARMS FOUND! for two seconds and the MG3000 issues an audible beep. .

Clear Alarms

To clear all alarms in the MG3000 enter the SYSTEM menu, then:

Warning: This will clear all recorded alarms the MG3000 has recorded and this action **CAN NOT BE UNDONE**. It is best to leave this action to a trained service technician.

- 1) Use the UP or DOWN buttons to select ALARMS.



ALARMS
CLEAR
VIEW

- 2) Press and hold the MODE button to enter the selection.
- 3) Use the UP or DOWN buttons to highlight CLEAR.
- 4) Press and hold the MODE button to make the selection.
- 5) Use the UP or DOWN buttons to select YES.
- 6) Press and hold the MODE button to save the selection. The LCD screen displays SETTING SAVED! and the MG3000 issues an audible beep.

Set Units

Use the Set Units menu to change the units for the data recorded in the MG3000 tachometer. Use the Set Units menu to change the units on all data or individual data type. For instance, change all units from US standard to Euro. The units of the following information can be changed; ALL UNITS, VOLUME, DISTANCE, SPEED, TEMPERATURE, DEPTH, PRESSURE, GPS COG and FLOW RATE. To make a change to the units, enter the System Menu then:

- 1) Use the UP or DOWN buttons to select SET UNITS.
- 2) Press and HOLD the MODE button to enter the selection.
- 3) Use the UP or DOWN buttons to select the data type to make a change to.
- 4) Press and hold the MODE button to enter the selection.
- 5) Use the UP or DOWN buttons to select the desired units type.

Data	Units Available		
All Units	US	EURO	
Volume	Gal	Liter	
Distance	Mile	Kilometer	Nautical Mile
Speed	MPH	KMH	Knots
Temperature	Fahrenheit	Celsius	
Depth	Feet	Meter	Fathom
Pressure	PSI	BAR	kPA
GPS COG	True	Magnetic	
Flow Rate	Gal Per HR	Liter Per HR	

- 6) Press and hold the MODE button to save the selection. The LCD screen displays SETTING SAVED! and the MG3000 issues an audible beep.

SYSTEM INFO
SET UNITS
SELF TEST
ALARMS

Performing A Self Test

Use the SELF-TEST feature to test the tachometer and gauges connected to the tachometer are communicating. To perform a Self-Test, enter the System Menu then:

- 1) Use the UP or DOWN buttons to select SELF TEST.
- 2) Press and hold the MODE button to enter SELF TEST.
- 3) Use the UP or DOWN buttons to select YES.
- 4) Press and hold the MODE button to begin the SELF TEST.

SYSTEM INFO
SELF-TEST
ALARMS
MASTER RESET

PERFORM
SELF TEST?
YES
NO

During the SELF-TEST:

The MG3000 tachometer will run through a series of scripted self test programs designed to test the operation of the tachometer. The pointer will move through a series of angles and the buzzer will beep. When finished the tachometer LCD will display SELF TEST COMPLETE and then cycle through a normal start up self test. Once complete the display will return to the NORMAL mode.

**THE
SELF TEST
MODE IS
IN PROGRESS**

Software Version

The Software feature is used to show the current version of software that is operating in the tachometer. This is particularly useful information when communicating with technical support.

To view the current Software version enter the System Menu, then:

- 1) Use the UP or DOWN buttons to select SOFTWARE.
- 2) Press and HOLD the MODE button to enter the selection.

The display will show

- the program identifier (starts with PGF followed by three numbers),
- the revision for the program identifier
- the release date for the software

**SYSTEM INFO
SOFTWARE
INITIALIZE
LANGUAGE**

**SOFTWARE
PGFXXX
REV: X##
MM/DD/YYYY**

Performing A Master Reset

The Master Reset feature is used to reset the tachometer to the factory default settings.

To perform a Master Reset, enter the SYSTEM menu, then:

- 1) Use the UP or DOWN buttons to select MASTER RESET.
- 2) Press and hold the MODE button to enter the selection.
- 3) When prompted to PERFORM MASTER RSET?. use the UP or DOWN buttons to select YES or NO.

If NO is selected the gauge will exit to the SYSTEM menu. If YES is selected continue with the next step.

A warning message will display for five seconds while beeping three times which is then replaced with "CONTINUE WITH RSET?".

- 4) Use the UP or DOWN buttons to select YES or NO.
- 5) Press and hold the MODE button to enter the selection.

If NO is selected, the gauge will exit to the SYSTEM menu.

If YES is selected, the MG3000 tachometer will be reset to factory default settings.

**SYSTEM INFO
MASTER RESET
SOFTWARE
INITIALIZE**

**PERFORM
MASTER RSET?
NO
YES**

**CAUTION! THIS
WILL RESET TO
FACTORY
SETTINGS**

**CONTINUE WITH
MASTER RSET?
NO
YES**

Fuel Set Up

Fuel Set Up is used to define the characteristics associated with each tank in the system and the Totalizer Functions. Use the Fuel Set Up screens to add fuel, reset the fuel used, set the tank size, select the fuel sender, calibrate the fuel sender, set the low fuel warning and select the fuel remaining source for each tank. The Totalizer settings are used to reset Totalizer fuel data and to set the Totalizer low fuel warning.

To enter the FUEL SETUP menu:

- 1) Press the MODE button once.
- 2) Use the UP or DOWN buttons to select EDIT MENU.
- 3) Press and hold the MODE button to enter the selection.
- 4) Use the UP or DOWN buttons to select FUEL SETUP.
- 5) Press and hold the MODE button to enter the selection.

EDIT MENU
FUEL SETUP
 TRIP DATA
 DISPLAY

Fuel Tank Setup

Use FUEL SETUP to set fuel tank capacity, select fuel sender, calibrate fuel sender, set the low fuel warning, add fuel, reset fuel used, and select fuel remaining source for each fuel tank.

Follow the steps below for performing each of these tasks:

- 1) Use the UP or DOWN buttons to select the fuel tank you wish to make adjustment to.
- 2) Press and hold the MODE button to enter the selection.
- 3) Follow the steps in the next sections.

SLECT TANK TO
ADD FUEL TO
T:1 FUEL
T:2 FUEL

Setting The Fuel Level

Setting the Fuel Level in the MG3000 tachometer is performed in the PORT tachometer if more than one MG3000 tachometer is in use. To set the fuel level to full enter the FUEL SETUP menu, then:

- 1) Use the UP or DOWN buttons to select SET FULL.
- 2) Press and hold the MODE button to set fuel tank to FULL.
- 3) At prompt, SET TANK FULL, use the UP or DOWN buttons to select YES, the fuel tank is full, or NO to return to the SET FUEL menu.
- 4) Use the MODE button to make the selection.

T#: FUEL
SET FULL
ADD FUEL

SET TANK FULL
NO
YES

If YES was selected the LCD screen will display SETTING SAVED! and then return you to the SET FUEL menu.

Adding Fuel to the Fuel Tank:

This measurement is used in calculating the Economy information like Trip and Fuel Used. If NO is selected you will be taken directly to the NORMAL mode.

T#: FUEL
ADD FUEL
SET FULL

- 1) Use the UP or DOWN buttons to select ADD FUEL
- 2) Press and hold the MODE button to enter the TANK # ADD menu.
- 3) Use the UP or DOWN buttons to set the volume of Fuel that has been added to the fuel tank.
- 4) Press and hold the MODE button to save the setting. The LCD screen displays SETTING SAVED! and the MG3000 issues an audible beep.

Note: Holding the UP or DOWN button will increase or decrease the amount in a more rapid fashion.



Setting The Tank Size

Enter the Fuel Setup menu then:

- 1) Use the UP or DOWN buttons to select TANK SIZE.
- 2) Press and hold the MODE button to enter the TANK SIZE menu.
- 3) Use the UP or DOWN buttons to set the capacity of the fuel tank.
- 4) Press and hold the MODE button to save the setting. The LCD screen displays SETTING SAVED! and the MG3000 issues an audible beep.

Note: Holding the UP or DOWN button will increase or decrease the amount in a more rapid fashion.

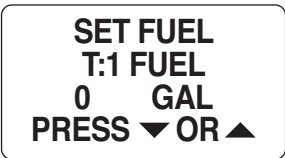
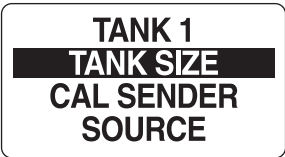

Calibrating The Fuel Sender

Each Fuel Tank sender can be individually calibrated using the steps below. The Fuel Sender can be calibrated by a 2, 3 or 5-point calibration. To begin the calibration the fuel tank must be empty. It is recommended that a 5-point calibration be performed to achieve the best fuel level accuracy. To calibrate the sender enter the FUEL SETUP menu then:

- 1) Use the UP or DOWN buttons to select CAL SENDER.
- 2) Press and hold the MODE button to enter the selection.
- 3) Use the UP or DOWN buttons to select the desired 2, 3, or 5 point calibration method.
- 4) Press and hold the MODE button to begin the calibration process.
- 5) Follow the on-screen prompts for each step of the calibration process. Be sure to press and hold the MODE button to save each calibration point. The LCD screen displays SETTING SAVED! and the MG3000 issues an audible beep.

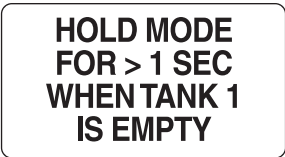
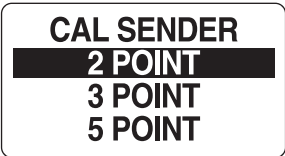

Low Fuel Warning Level

The low warning alarm is used to let the user know when the tank has emptied below a set volume. To set the LOW WARN alarm enter the FUEL SETUP menu select a tank then:

- 1) Use the UP or DOWN buttons to select LOW WARN.
- 2) Press and hold the MODE button to enter the selection.
- 3) Use the UP button to increase or the DOWN button decrease the low fuel warning



level.

- 4) Press and hold the MODE button to save the setting. The LCD screen displays SETTING SAVED! and the MG3000 issues an audible beep.

Note: Holding the UP or DOWN button will increase or decrease the amount in a more rapid fashion.

Fuel Totalizer

The Fuel Totalizer is used when more than one Fuel Tank is installed in the system. The Totalizer will monitor all the installed Fuel Tanks, gather the data and combine for fuel usage data that represents the entire system. The MG3000 automatically collects the fuel data based on the settings in the individual tank settings completed in FUEL SETUP. If you have not completed the individual tank set up go to Fuel Set.

The Fuel Totalizer allows the user to select TFUEL USED, TFUEL LEFT, TFUEL INST TFUEL FLOW or TFUEL AVG in the default pages set up.

TFUEL USED - Total Fuel Used - Displays the total amount of fuel used since the last reset.

TFUEL LEFT - Total Fuel Left - Displays the total amount of fuel left since last reset.

TFUEL INST - Total Instantaneous Fuel Flow - Measures how much fuel is flowing at this time for all engines combined into one amount.

TFUEL AVG - Total Average Fuel Flow - Average of fuel flow from all engines taken over a period of time.

To reset the Totalizer Fuel Used:

The only user selectable function in the Fuel Totalizer is the RESET TOTALIZER.

Warning: Resetting the totalizer will also reset all collected Fuel economy data.

To reset the Fuel Totalizer:

- 1) Press and hold the MODE button from the NORMAL mode.
- 2) Use the UP or DOWN buttons to select RESET TFUEL.
- 3) When prompted, RESET DATA? use the UP or DOWN buttons to select YES to reset the totalizer fuel used, or select NO to exit.
- 4) Press and hold the MODE button to save the setting. The LCD screen displays SETTING SAVED! and the MG3000 issues an audible beep.

HOLD MODE
TO ENTER
RESET TOTLIZR
TRIP DATA

TOTALIZER
RESET?
NO
YES

Max Speed

The Max Speed function records the highest speed during the last period since reset. To view or reset the max speed enter the EDIT menu then:

- 1) Use the UP or DOWN buttons to select MAX SPEED.
- 2) Press and hold the MODE button to enter the selection.
- 3) Follow the steps in the next sections.

EDIT MENU
MAX SPEED
 DISPLAY
 DATA SOURCES

View Max Speed

- 1) Use the UP or DOWN buttons to select VIEW.
- 2) Press and hold the MODE button to enter the selection.

MAX SPEED
VIEW
 RESET

Note: The MAX SPEED is displayed on the MG3000 tachometer display.

MAX SPEED

57.4 MPH

Resetting Max Speed

- 1) Use the UP or DOWN buttons to select RESET.
- 2) Press and hold the MODE button to enter the selection.
- 3) Use the UP or DOWN buttons to select YES to reset the Max Speed or NO to exit.
- 4) Press and hold the MODE button to reset the data. The LCD screen displays SETTING SAVED! and the MG3000 issues an audible beep.

MAX SPEED
RESET
 VIEW

Calibrate Speedometer

Note: The speed calibration requires the boat speed to be in the range of the device your are calibrating. If you are calibrating the paddle wheel, the boat speed must be below the transition point. If you are calibrating the pitot, the boat speed must be above the transition point.

The transition point is the point where the speed sender is changed from the paddlewheel to the pitot tube. Typically, the paddle wheel is best for low speeds and the pitot tube is best for higher speeds.

- 1) Press the MODE button once.
- 2) Use the UP or DOWN buttons to select EDIT MENU.
- 3) Press and hold the MODE button to enter the selection.
- 4) Use the UP or DOWN buttons to select CAL SPEEDO.
- 5) Press and hold the MODE button to enter the selection.

EDIT MENU
CAL SPEEDO
 CAL TRIM
 FUEL SETUP

Set Sender Transition

To set the transition point enter the CAL SPEEDO menu, then:

- 1) Use the UP or DOWN buttons to select SET SENDR TRSN.
- 2) Press the MODE button to make the selection.
- 3) Use the UP or DOWN buttons to set the speed in which the transition will take place.
- 4) Use the MODE button to save the setting.

CAL SPEEDO
SET SENDR TRSN
 CAL PADDLEWHL
 CAL PITOT

SET SENDER
 TRANSITION
 00.0 MPH
 PRESS ▼ OR ▲

Calibrate Paddle Wheel sender

Note: The speed calibration requires the boat speed to be below the transition point. Set the boat speed in the mid range. Verify speed using a known reference source, ie GPS or other standard.

- 1) Use the UP or DOWN buttons to select CAL PADDLEWHL.
- 2) Press the MODE button to make the selection.
- 3) Use the UP or DOWN buttons to set the speed to match the known reference standard.
- 4) Use the MODE button to save the setting.

CAL SPEEDO
CAL PADDLEWHL
 CAL PITOT
 SET SENDR TRSN

CALIBRATE
 MID RANGE
 00.0 MPH
 PRESS ▼ OR ▲

Calibrate Pitot sender

Note: The speed calibration requires the boat speed to be above the transition point. Set the boat speed in the mid range. Verify speed using a known reference source, ie GPS or other standard.

- 1) Use the UP or DOWN buttons to select CAL PADDLEWHL.
- 2) Press the MODE button to make the selection.
- 3) Use the UP or DOWN buttons to set the speed to match the known reference

CAL SPEEDO
CAL PITOT
 SET SENDR TRSN
 CAL PADDLEWHL

CALIBRATE
 MID RANGE
 00.0 MPH
 PRESS ▼ OR ▲

standard.

- 4) Use the MODE button to save the setting.

Calibrate Trim

To calibrate the Trim sender enter the EDIT menu then:

- 1) Use the UP or DOWN buttons to select CAL TRIM.
- 2) Use the MODE button to make the selection.
- 3) Lower the Trim tab to the full DOWN position. Use the MODE button to save the setting.
- 4) Raise the Trim tab to the full UP position. Use the MODE button to save the setting. The LCD screen displays SETTING SAVED! and the MG3000 issues an audible beep.



Display Settings

The Display Settings control the data page's appearance and functionality. Use the display settings set the number of data pages shown, edit the data fields that are shown on each page, select the default data page, turn on or off the Normal Mode auto scrolling feature and to set the display units.

To change the display settings:

- 1) Press the MODE button once.
- 2) Use the UP and/or DOWN buttons to select the EDIT MENU.
- 3) Press and hold the MODE button to enter the selection.
- 4) Use the UP and/or DOWN buttons select DISPLAY.
- 5) Press and hold the MODE button to enter the selection.
- 6) Press and hold the MODE button to enter the selection.

EDIT MENU
DISPLAY
 DATA SOURCES
 POP UP ALERTS

Setting the Number of Data Pages

Each data page can contain up to two data fields. To increase or decrease the number of data pages shown in Normal Mode enter the DISPLAY menu, then:

- 1) Use the UP and/or DOWN buttons to select # OF SCREENS.
- 2) Press and hold the MODE button to enter the selection.
- 3) Use the UP button to increase or the DOWN button to decrease the number of data pages.
- 4) Hold the MODE button to save the selection. The LCD screen displays SETTING SAVED! and the MG3000 issues an audible beep.

DISPLAY
OF SCREENS
 SCREEN SETUP
 LINE 2 DATA

SELECT # OF
 SCREENS
1
 PRESS ▲ OR ▼

Screen Setup

Use the Screen Setup to select the data fields that are shown on each page in Normal Mode. See **DEFAULT PAGES AND DISPLAY SETTINGS** on page 6. To edit the data fields displayed, enter the DISPLAY menu, then:

- 1) Use the UP and/or DOWN buttons to select SCREEN SETUP.
- 2) Press and hold the MODE button to enter the selection.
- 3) Use the UP or DOWN buttons to select the page number to edit the data fields.
- 4) Hold the MODE button to enter the page to edit.
- 5) Use the UP or DOWN buttons to select the data field to display on line one.
- 6) Press and hold the MODE button to save the selection. The LCD screen displays SETTING SAVED! and the MG3000 issues an audible beep.

DISPLAY
SCREEN SETUP
 LINE 2 DATA
 AUTO SCROLL

SCREEN #
 TO SET UP
1
 PRESS ▼ OR

SCREEN #
BATTERY 1
0.0 V
 PRESS ▼ OR ▲

Setting the Line 2 Data

The MG3000 can show limited data on the second line of the LCD display. To select the Line 2 data enter the DISPLAY menu, then:

- 1) Use the UP and/or DOWN buttons to select LINE 2 DATA.

- 2) Press and hold the MODE button to enter the selection.
- 3) Use the UP or DOWN button to select the data you wish to see in the line 2 display.

Note: The choices for the Line 2 Data can be selected from Fuel Level, Trim, Load, Water Level, Oil Level and OFF.

- 4) Hold the MODE button to save the selection. The LCD screen displays SETTING SAVED! and the MG3000 issues an audible beep.

Data Page Auto Scroll Setting

The AUTO SCROLL feature, when active, automatically scrolls through the data pages at a user-defined interval. To set up and activate the auto scroll feature enter the DISPLAY menu, then:

- 1) Use the UP and/or DOWN buttons to select AUTO SCROLL.
- 2) Press and hold the MODE button to enter the selection.
- 3) Use the UP or DOWN button to select STATUS.
- 4) Hold the MODE button to enter the selection.
- 5) Use the UP or DOWN buttons to select ON or OFF.
- 6) Press and hold the MODE button to save the status selection. The LCD screen displays SETTING SAVED! and the MG3000 issues an audible beep.

To change the Auto Scroll interval Time:

- 1) Use the UP or DOWN buttons to select TIME.
- 2) Press and hold the MODE button to enter the selection.
- 3) Use the UP button to increase or the DOWN button to decrease the interval.
- 4) Press and hold the MODE button to enter the selection.

The minimum Auto Scroll interval is one (1) second, the maximum interval is sixty (60) seconds.

- 5) Press and hold the MODE button to save the interval setting. The LCD screen displays SETTING SAVED! and the MG3000 issues an audible beep.

LCD Color

The MG3000 gauge package has the ability to change the color of the LCD back light. To change the color of the LCD back lighting enter the DISPLAY menu, and then:

- 1) Use the UP or DOWN buttons to select LCD COLOR.
- 2) Press and hold the MODE button to enter the selection.
- 3) Use the UP or DOWN buttons to select the desired color.

Note: The color choices are WHITE, YELLOW, PINK, CORAL, TAN, PURPLE, AQUA GREEN or BLUE.

- 4) Press and hold the MODE button to save selection.

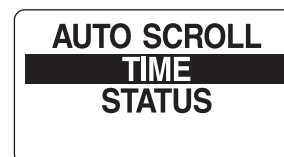
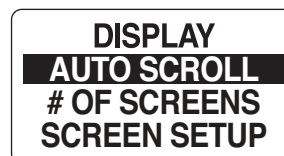

Data Sources

Use DATA SOURCES to set the engine instance and to set or reset the maintenance interval for the engine. Use the data source menu to set the instance ID for the 2" gauges connected to the tachometer for Battery and Oil Level gauges.

The MG3000 tachometer is capable of using up to five analog senders for Fuel, Trim, Ballast, Bait Well, Rudder, Fresh Water, Gray Water or Black Water.

Refer to your manufacturers Gauge Installation Guide of installation instructions for input values. To enter the data sources menu:

- 1) Press the MODE button once.
- 2) Use the UP and/or DOWN buttons to select EDIT MENU.
- 3) Press and hold the MODE button to enter the selection.
- 4) Use the UP or DOWN buttons to select DATA SOURCES .
- 5) Press and hold the MODE button to enter the selection.

EDIT MENU
DATA SOURCES
 POP UP ALERTS
 SYSTEM INFO

Tanks

The Tanks data source is where the source of the information that is received from a particular tank will display. The MG3000 tachometer can display information from an analog (US 240-33, EU 10-180 Fuel Senders), or digital sources (Bus Data). To make changes to the Tanks data source enter the DATA SOURCES menu, then:

- 1) Use the UP and/or DOWN buttons to select TANKS.
- 2) Press and hold the MODE button to enter the selection.
- 3) Use the UP or DOWN buttons to select the TANK # to make changes to.
- 4) Press and hold the MODE button to enter the selection.
- 5) Use the UP or DOWN buttons to select TANK SOURCE.
- 6) Press and hold the MODE button to save the new selection. The LCD screen displays SETTING SAVED! and the MG3000 issues an audible beep.

Note: If an Analog source is picked you will be prompted to choose which pin the analog signal is attached to the tachometer. Select the connector pin which the analog input is attached. See the Wiring Diagram on page 2 for available pin points.

T1 (Tank 1) is programmed as a Fuel tank and the source is the fuel level sender by default.

T2 (Tank 2) is programmed as an Oil tank and the source is the oil level sender by default.

- 7) Repeat for all tanks.

Engine

The Engine Data Source was set during initialization. If there is a need to change the Engine ID enter the DATA SOURCES menu, then:

- 1) Use the UP and/or DOWN buttons to select ENGINE.

DATA SOURCES
TANKS
 ENGINE
 FUEL REMAIN

TANK SOURCE
T1: XXXXX
 T2: XXXXX
 T1: XXXX2

TANK 1 SOURCE
US 240-33
 EU 10-180
 BUS DATA - 0

ANALOG
#1 P1 - 6
 #2 P1 - 7
 #3 P1 - 8

DATA SOURCES
ENGINE
 FUEL REMAIN
 TANKS

- 2) Press and hold the MODE button to enter the selection.
- 3) Use the UP or DOWN buttons to select ENGINE ID .
- 4) Press and hold the MODE button to enter the selection.
- 5) Use the UP or DOWN buttons to select Engine ID.

Note: You can set the engine ID to STARBOARD - Default one engine setup - MID PORT, CENTER, MID STARBOARD and STARBOARD.

- 6) Press and hold the MODE button to save the new ENGINE ID. The LCD screen displays SETTING SAVED! and the MG3000 issues an audible beep.



Engine Maintenance Interval

The MG3000 tachometer monitors the engine hours and notify the operator when maintenance is needed. To set the MAINTENANCE INTERVAL enter the DATA SOURCES menu, then:

- 1) Use the UP and/or DOWN buttons to select ENGINE.
- 2) Press and hold the MODE button to enter the selection.
- 3) Use the UP or DOWN buttons to select MAINT INTRVL.
- 4) Press and hold the MODE button to enter the selection.
- 5) Use the UP button to increase, or the DOWN button to decrease the Maintenance Interval. (Refer to your ENGINE OWNERS MANUAL for the recommended maintenance interval.)

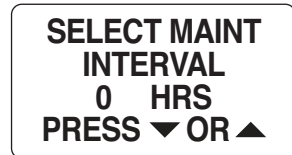
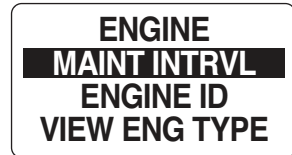

Note: A POP UP window will open when the Maintenance Interval is reached.

- 6) Press and hold the MODE button to save the setting. The LCD screen displays SETTING SAVED! and the MG3000 issues an audible beep.

Reset the Maintenance Interval:

- 1) Use the UP and/or DOWN buttons to select ENGINE.
- 3) Press and hold the MODE button to enter the selection.
- 4) Use the UP or DOWN buttons to select RESET INTRVL.
- 5) Press and hold the MODE button.

At the prompt: RESET MAINT INTERVAL YES/NO

- 6) Use the UP or DOWN buttons to select YES to reset the maintenance interval, or select NO to exit. The LCD screen displays SETTING SAVED! and the MG3000 issues an audible beep.



View Engine ID

To view the engine ID enter the DATA SOURCES menu then:

- 1) Use the UP and/or DOWN buttons to select ENGINE.
- 2) Press and hold the MODE button to enter the selection.
- 3) Use the UP or DOWN buttons to select ENGINE ID.



- 4) Press and hold the MODE button to enter the selection.
- 5) Use the UP or DOWN buttons to select the location of the engine, the engine ID.
- 6) Press and hold the MODE button to save selection.

SET ENGINE ID
PORT
MID PORT
CENTER

Remaining Fuel Source

The Remaining Fuel Source can be changed in the Edit menu. Enter the DATA SOURCES menu, then:

- 1) Use the UP and/or DOWN buttons to select FUEL REMAIN.
- 2) Use the MODE button to make the selection.
- 3) Use the UP or DOWN buttons to select either ENG FUEL RATE or FUEL LEVEL to determine how the level of fuel remaining is found.
- 4) Press and hold the MODE button to save the selection. The LCD screen displays SETTING SAVED! and the MG3000 issues an audible beep.

DATA SOURCES
FUEL REMAIN
TANKS
ENGINE

REMAINING
FUEL SOURCE
FUEL LEVEL
ENG FUEL RATE

Pop Up Messages

The Pop Up feature alerts users when a change occurs in a monitored data field. The MG3000 tachometer has Pop Ups available for RPM, TRIM CHANGE, FUEL ECONOMY, SPEED, WATER TEMP, EST RANGE and DURATION.

By default all Pop Up messages set to OFF. To turn ON pop ups and set the threshold for data fields:

- 1) Press the MODE button once.
- 2) Use the UP or DOWN buttons to select the EDIT MENU.
- 3) Press and hold the MODE button to enter the selection.
- 4) Use the UP or DOWN buttons to select POP UP ALERTS.
- 5) Press and hold the MODE button to enter the selection.

EDIT MENU
POP UP ALERTS
SYSTEM
FUEL SETUP

POP UP ALERTS
RPM
TRIM CHANGE
FUEL ECON

RPM
POP UP
STATUS
VALUE

To turn a POP UP alert ON or OFF

- 1) Use the UP or DOWN buttons to select the POP UP alert you wish to use.
- 2) Press and hold the MODE button to make the selection.
- 3) Use the UP or DOWN buttons to select STATUS.
- 4) Press and hold the MODE button to enter the selection.
- 5) Use the UP or DOWN button to select ON or OFF.
- 6) Press and hold the MODE button to save the selection.

RPM
POP UP STATUS
OFF
ON

RPM
POP UP
VALUE
STATUS

To set the POP UP threshold value:

The POP UP threshold value is the value that will trigger a POP UP alert to activate.

- 1) Use the UP or DOWN button to select VALUE.

RPM
POP UP VALUE
100 RPM
PRESS ▲ OR ▼

- 2) Press and hold the MODE button to enter the selection.
- 3) Use the UP or DOWN buttons to set the desired value to activate the pop-up.
- 4) Press and hold the MODE button to save the setting. The LCD screen displays SETTING SAVED!.

Setting the Pop Up Duration

The Pop Up Duration setting defines the amount of time a Pop Up screen remains active before returning to current the Normal Mode Data Page. Follow the steps below to edit the Pop Up Duration:

- 1) Use the UP or DOWN buttons to select DURATION.
- 2) Press and hold the MODE button to enter the selection.
- 3) Press the UP button to increase or the press the DOWN button to decrease the pop up duration.
- 4) Press and hold the MODE button to save the setting. The LCD screen displays SETTING SAVED! and the MG3000 issues an audible beep.



Troubleshooting

Use a process of elimination to troubleshoot network problems.

1. If the MG3000 digital gauge package is displaying values of "0" for data fields it indicates the gauge is not receiving the data signal from one or more devices.
 - Make sure data sources are configured.
 - If multiple data fields are displaying "0", check common items such as cables and t-connectors.
 - Remove components from the network one at a time to isolate the failing component.
 - Look for damaged parts. Check connectors for corrosion.
 - Swap known good components (sensor, cables or tees) to isolate the faulty component.
 - Reconnect the good components to the network and remove the next one in line.
 - Continue the process for each device, cable or tee connector on the network until the faulty part is found.

Note: Once components are reconnected, if the digital display continues to show "0", turn the power to the network OFF and back ON to reset the gauge(s).

Engine Warnings

The MG3000 tachometer monitors engine conditions and displays warnings in the event of a malfunction. Refer to the outboard *Operator's Guide* if any engine warnings are displayed.

Engine Warning	LCD	Type of Error	Possible Cause	Procedure
Over Heat	RED	Critical	The engine is over heating	Seek assistance to return to a safe harbor immediately and see your dealer.
Engine Oil Pressure Low	RED	Critical	Engine Oil Pressure is LOW	
Low Oil Critical	AMBER	Warning	The level in the on-engine 2 stoke oil tank is low.	
Low Oil	AMBER	Warning	The level in the 2 stoke oil tank is low.	
Engine Over speed	RED	Critical	Engine speed is too high	Reduce Engine Speed
Battery Voltage High	AMBER	Warning	Battery Voltage is above normal limit	
Battery Voltage Low	AMBER	Warning	Battery Voltage is below normal limit	
Water Pressure	RED	Critical	Water pressure in the cooling system is low	
OBD Service Soon	AMBER	Critical	Problem with catalytic converter or other emissions/exhaust components.	See dealer soon.

Clearing Engine Warnings

There is no way to clear an Engine Warning except to repair the condition which prompted the warning.

Silence the Warning

- 1) Press and hold the MODE button to silence the alarm. The warning light will remain active and the Engine Warning screen will display the warning in the Normal mode. Once the condition that prompted the warning is repaired the warning light will return to normal. If the condition persists the ENGINE WARNING will pop up after a short interval, usually about 5 minutes.

Network Troubleshooting Chart

Observation	Possible Cause	Procedure
"0" displayed for data fields	Data sources are not configured	Use DATA SOURCES menu to configure data source.
Tachometer does not power on.	Power supply harness fuse blown.	Check the Power Supply harness, fuses and switched B+ from the ignition harness. See Note below.
Power Supply harness blown fuse	Network current draw is exceeding 3A.	Check all connections and wiring. Disconnect accessory connections to network. Isolate possible overloads or shorted accessory.
No Speed display.	Requires input from SmartCraft Speed transducer, GPS or paddle wheel. Requires input from SmartCraft GPS. Requires SmartCraft depth transducer. Requires SmartCraft temperature transducer or analog sender. Requires fuel level sensor or analog sender. Requires input from SmartCraft GPS.	Check that the device is installed and connected to the network.
Speed Over Water (SOW) does not display.		
Speed Over Ground (SOG) does not display.		
Water depth does not display.		
Sea water temperature does not display.		
Fuel tank level does not display.		
No "Fuel Econ".		

Note: The tachometer harness of the MG3000 network must be connected to the SmartCraft network using the device port of a t-connector.

Misaligned t-connectors can cause the SmartCraft network power supply fuse to blow and disrupt or eliminate communications in the system.

Observation	Possible Cause	Procedure
Oil tank level does not display.	Requires input from oil tank sender.	Each oil tank uses an outboard position-specific converter.
Engine water pressure does not display.	Requires input from a water pressure transducer.	Use diagnostics equipment to set the water pressure sensor setting.
Water pressure faults after initial setup.	Water pump is faulty. The block-mounted water pressure sensor is not connected to the engine EMM. The SmartCraft network water pressure sensor is not configured properly. Engine EMM is not correctly configured for the water pressure sensor.	Verify the operation of the water pump. Check the connection for the block-mounted water pressure sensor at the engine EMM. Replace the SmartCraft water pressure with a known good component. Use diagnostics equipment to verify the water pressure sensor setting.
Instrument display is erratic.	Power supply batter voltage is less than 12.5V. One or more terminators are missing from the SmartCraft network.	Check for a minimum 12.5 V across the terminals of the power supply battery. Check for installation of two terminators on the SmartCraft network. Check network bus cable and device connections.
Gauge repeatedly reset to factory defaults.	If this occurs during heavy power use possible poor battery condition exists.	Check system supply battery voltage with engine running. Check ignition and ground connections on pins 4 and 5 of the tachometer.

Abbreviations Used - Tachometer

Abbreviation	Function
RPM	Engine Speed, Revolutions per minute.
OIL PRESS	Oil Pressure
OIL TEMP	Oil Temperature
COOLANT	Coolant Temperature
PORT TEMP	Engine Temperature
PORT HOURS	Engine Hours
TRANS GEAR	Gear Position
TRANS PRESS	Transmission Oil Pressure
THROTTLE	Throttle Percentage
ENGINE LOAD	Engine Load
FUEL TANK #	Fuel Tank 1-5
FUEL USED	Fuel Used
FUEL LEFT	Fuel Remaining
FUEL INST	Instantaneous Fuel Flow
FUEL FLOW	Average Fuel Flow
OIL LEVEL	Oil Level 1-5
BAITWELL	Bait Well
BLACK WATER	Black Water
GRAY WATER	Gray Water
RUDDER	Rudder Angle
BAROMETER	Barometric Pressure
TRIP A HOURS	Trip A Engine Hours
BATTERY #	Battery Identification
BOOST	Engine Boost
ODOMETER	Odometer
BTN	Button
CAL	Calibrate
CLR	Clear
CRRNT	Current
CUSTM ALRMS	Custom Alarms
DEG	Degree
DEPDNT	Dependent
DFLT	Default
DIAG MODE	Diagnostic Mode
ECON	Economy
ENGINE ID	Engine Identification
EST	Estimated
EURO	European
GMT	Greenwich Mean Time
GPS	Global Positioning System
INDPDNT	Independent
INSTRMENT	Instrument

Abbreviation	Function
TFULE USED	Total Fuel Used
TFUEL LEFT	Total Fuel Remaining
TFUEL INST	Total Instantaneous Fuel Flow
TFUEL AVG	Total Average Fuel Flow
FUEL ECON	Fuel Economy
LAT/LONG	Latitude/Longitude
GPS SPEED	GPS Speed
COG	Course Over Ground
CLOCK	Clock
HEADING	Heading
BATTERY #	Battery 1-5
TRIM	Trim
DEPTH	Depth
WATER PRESS	Water Pressure
BALLAST #	Ballast Tank 1-5
TRIP A	Trip A Fuel Used
TRIP A ODO	Trip A Odometer
TRIP A FAVG	Trip A Average Fuel Flow
SEASN HOURS	Season Engine Hours
SEASN FUEL	Season Fuel Used
SEASON ODO	Season Odometer
SEASN FAVG	Season Average Fuel Flow
FRESH WATER	Fresh Water Tank
EST RANGE	Estimated Range
INTRVL	Interval
LVL	Level
MAINT INTRV	Maintenance Interval
MID PORT	Middle Port Engine
MID STRBD	Middle Starboard Engine
MSTR	Master
PRESS	Pressure
RSET	Reset
REMAIN SRC	Remaining Source
SCRNS	Screens
SET	Setting
SPEEDO	Speedometer
SRCS	Sources
TEMP	Temperature
WARN	Warning
W/O	With Out
#	Number

Warning Buzzer

Both the MG3000 Tachometer and the Speedometer have internal buzzers that are used for audio settings that are controllable via the gauges' edit menus.

Default Functions Displayed in LCD by Engine Type

The below default screens list represents the screens set by the manufacturer. These screens can be changed by the operator and may not reflect your system.

Common to all styles of engines

Break In - removed when time completed.

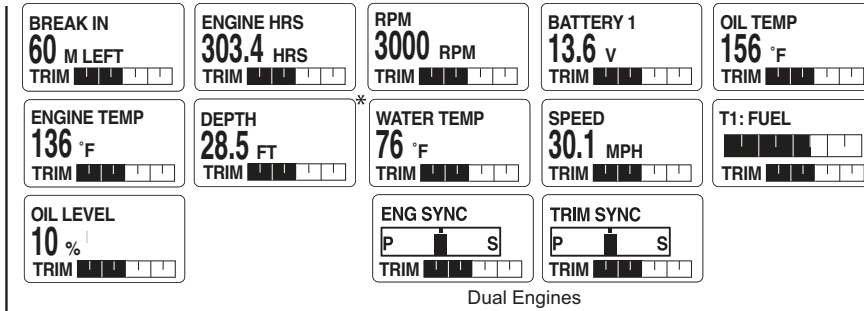

* Available only with SmartCraft Depth bus data.

2 Cycle Outboard - all common screens and add:



4 Cycle Outboard - all common screens and add:

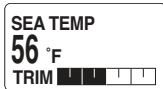

Inboard/Outboard and 4-cycle Inboards - all common screens and add:



Verado - all common screens and add:

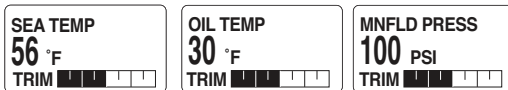

Diesel - all common screens and add:

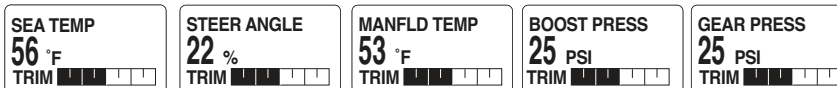

Jet Drive - all common screens and add:

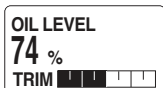

Troll Control



Use the UP and DOWN buttons together in the Normal mode for 1 second to enter TROLL mode.

Smart Tow



Use the UP and DOWN buttons together in the Normal mode for more than 1 second to enter "Smart Tow" mode.

Additional Screens

ENG SYNC	OIL PRESS
ENGINE LOAD	CLOCK
ENGINE HOURS	COG
EXHST TEMP	FRESH WATER
THROTTLE	FUEL ECON
TRIM	WATER PRESS
TRIM SYNC	WASTE WATER
FUEL LEVEL	FUEL USED
GPS SPEED (SOG)	FUEL PRESS
LATITUDE	FUEL FLOW
LONGITUDE	GEAR PRESS
RUDDER	BOOST PRESS
FUEL LEFT	MNFLD PRESS
FUEL INST	MNFLD TEMP
EST RANGE	SEASN HOURS
TRIP A HOURS	SEASN ODO
TRIP A ODO	SEASN FUEL
TRIP A FUEL	SEASN FAVG
TRIP A FAVG	TFUEL FLOW
TRIP B HOURS	TFUEL LEFT
TRIP B ODO	TFUEL INST
TRIP B FUEL	TFUEL USED
TRIP B FAVG	TFUEL AVG

NORMAL MODE

TO EDIT MODE

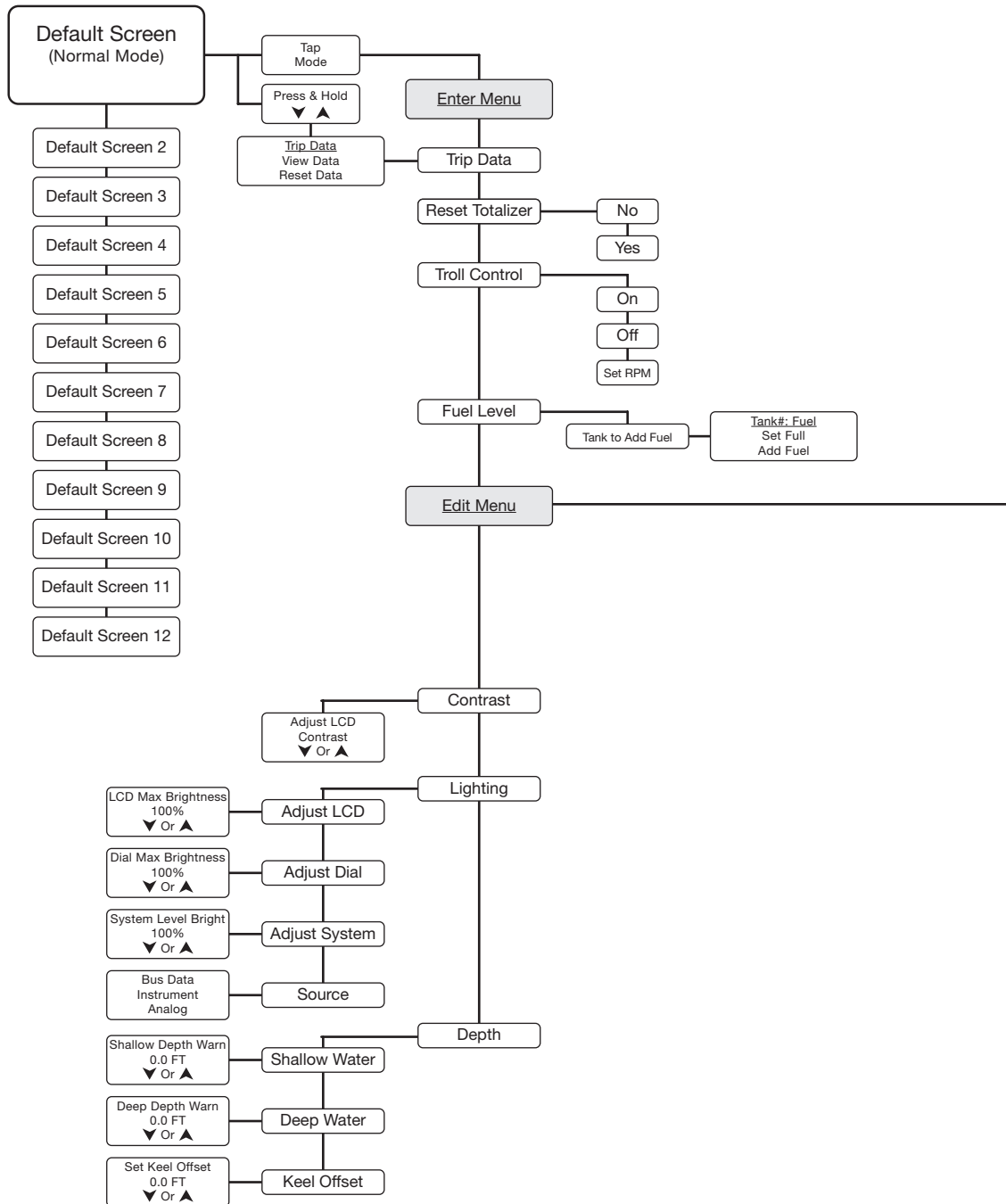

FROM NORMAL MODE

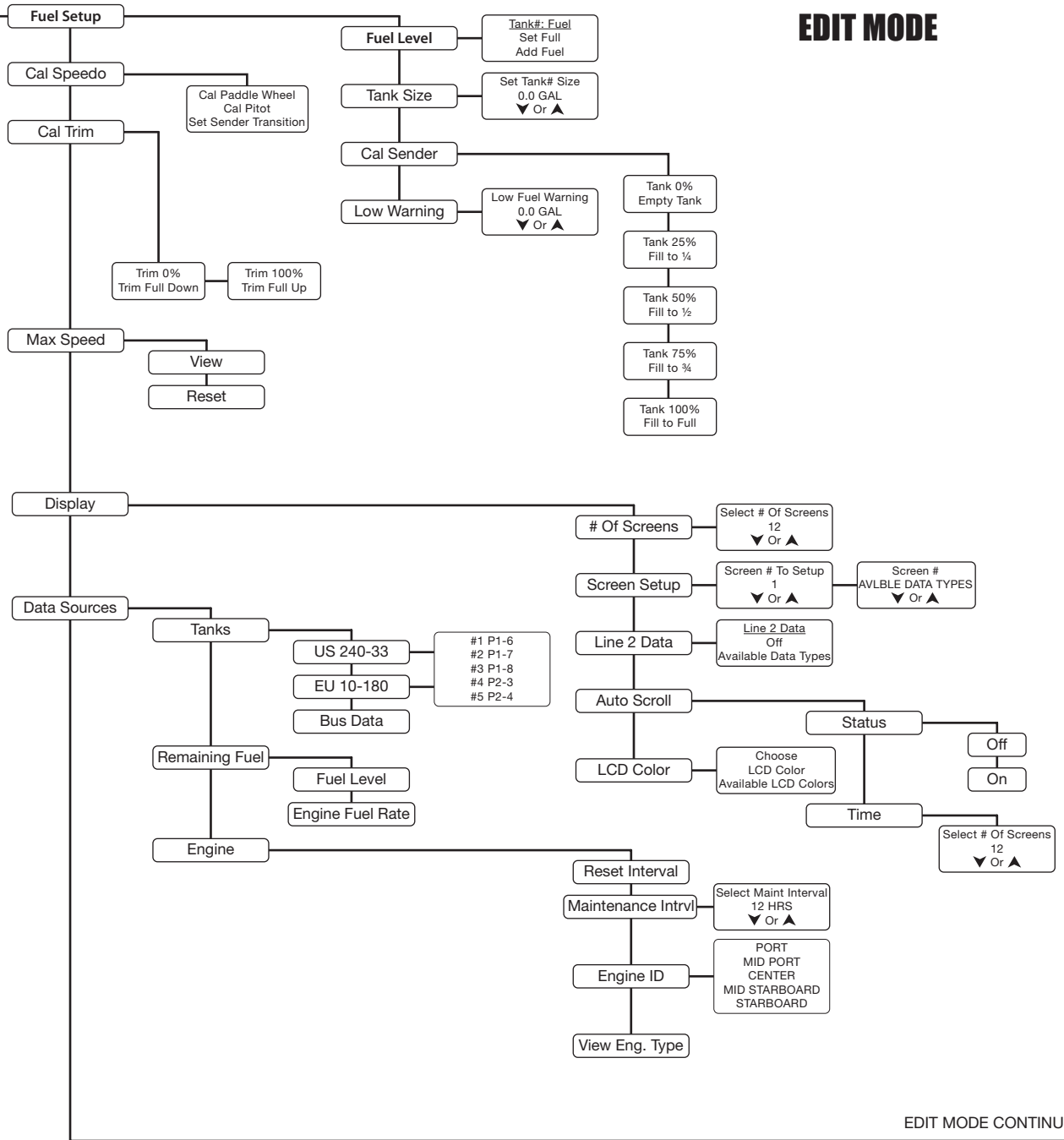

EDIT MODE CONTINUED

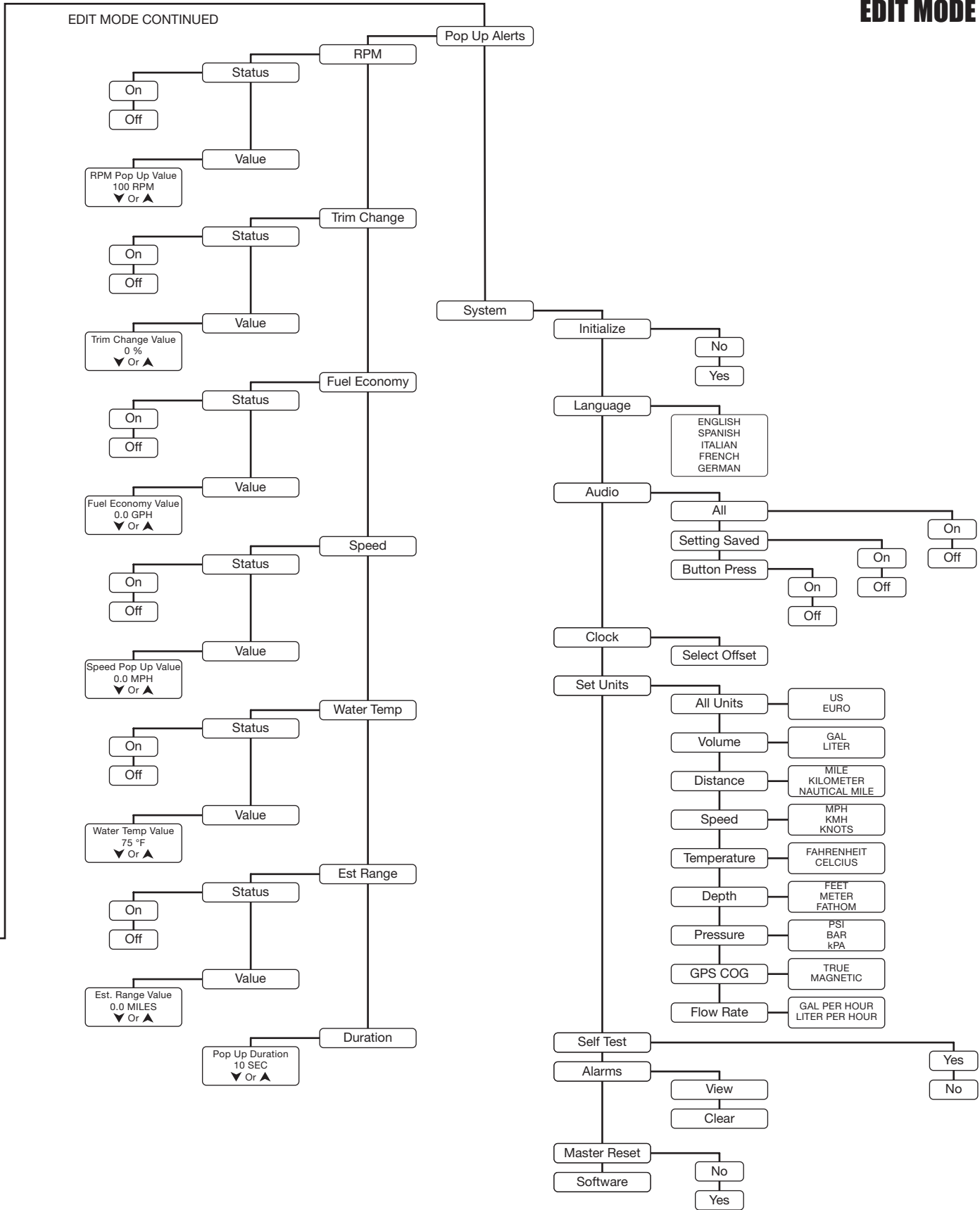

Faria Corporation
P.O. Box 983 - 385 Norwich-New London Turnpike
Uncasville, CT 06382, USA
860.848.9271